

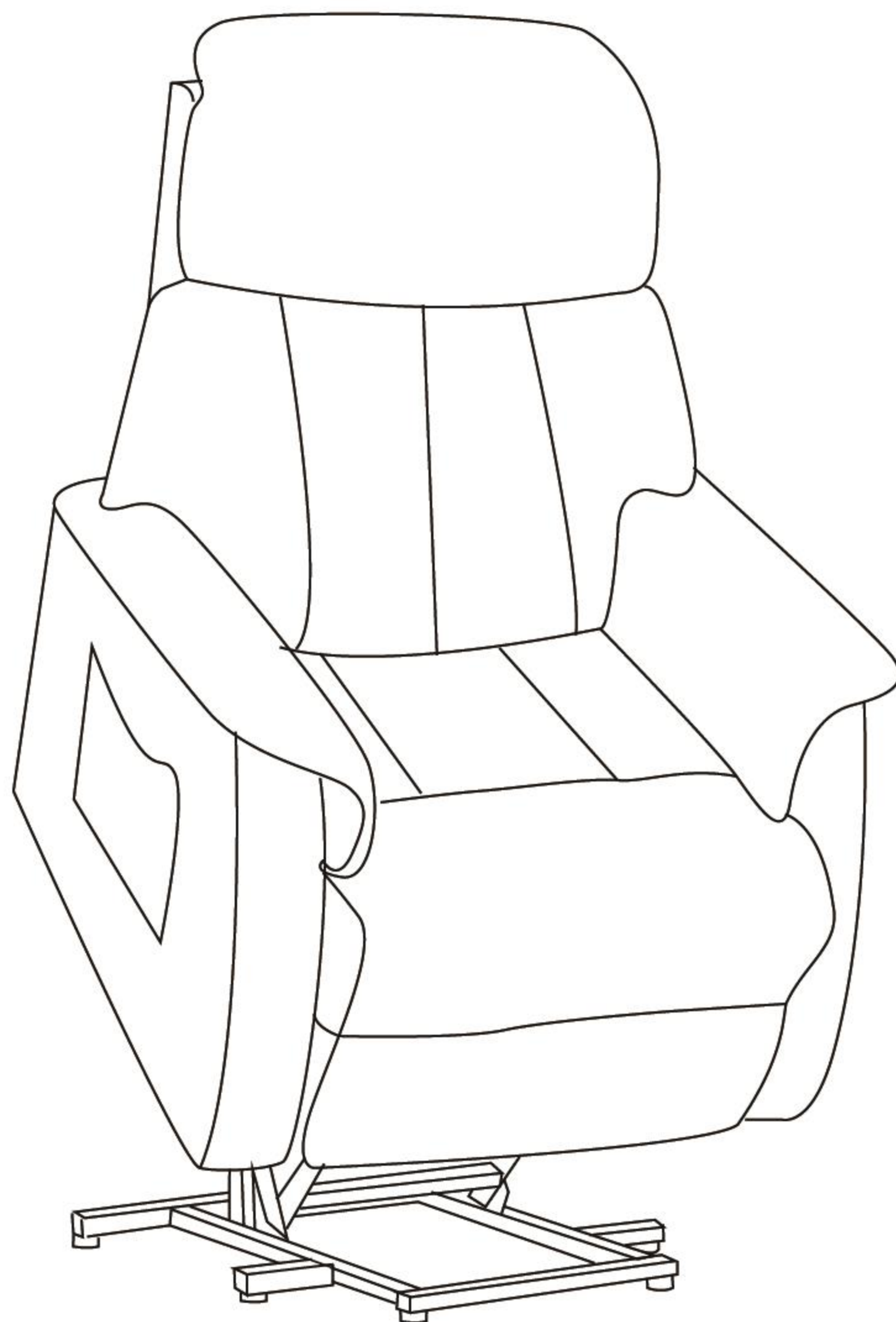

**MCombo**

# Sofa assembly instruction

(English / Deutsch / Français / Español / Italiano)



**Pfillo GmbH**

6160-7299

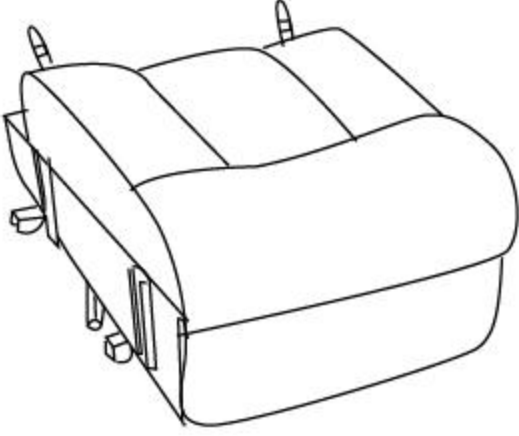
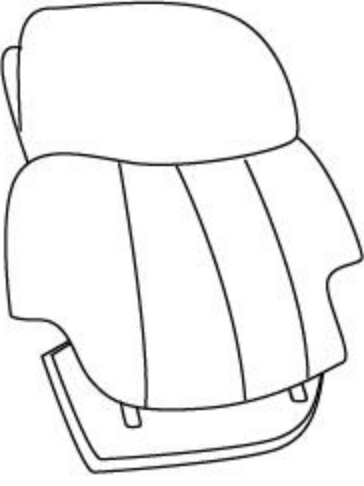
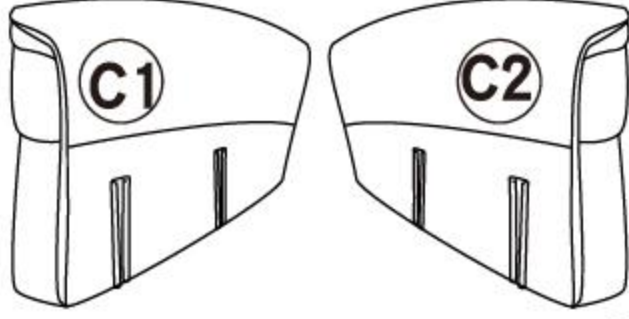
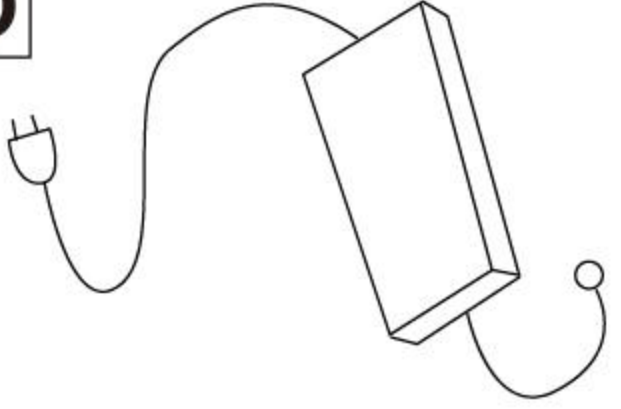
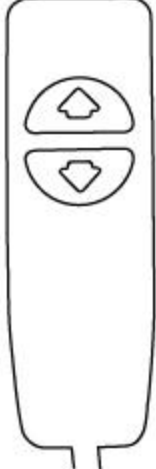
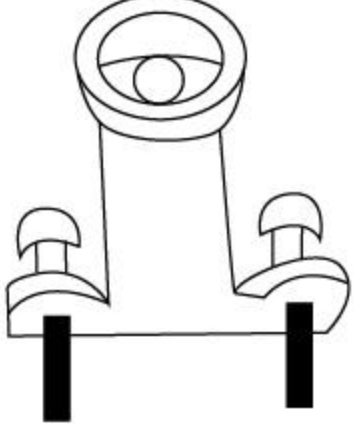
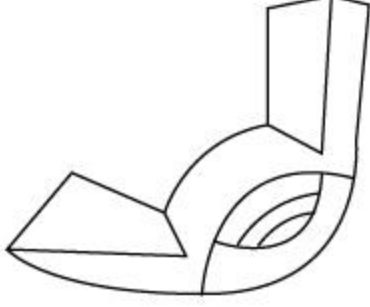

# Sofa assembly instruction

<b>A</b>  Chair base 1x	<b>B</b>  Backrest 1x	<b>C</b>  Left and right armrest 2x	<b>D</b>  Power cord 1x
<b>E</b>  Remote control 1x	<b>F</b>  Part1 2x	<b>G</b>  Part2 4x	

## Step1

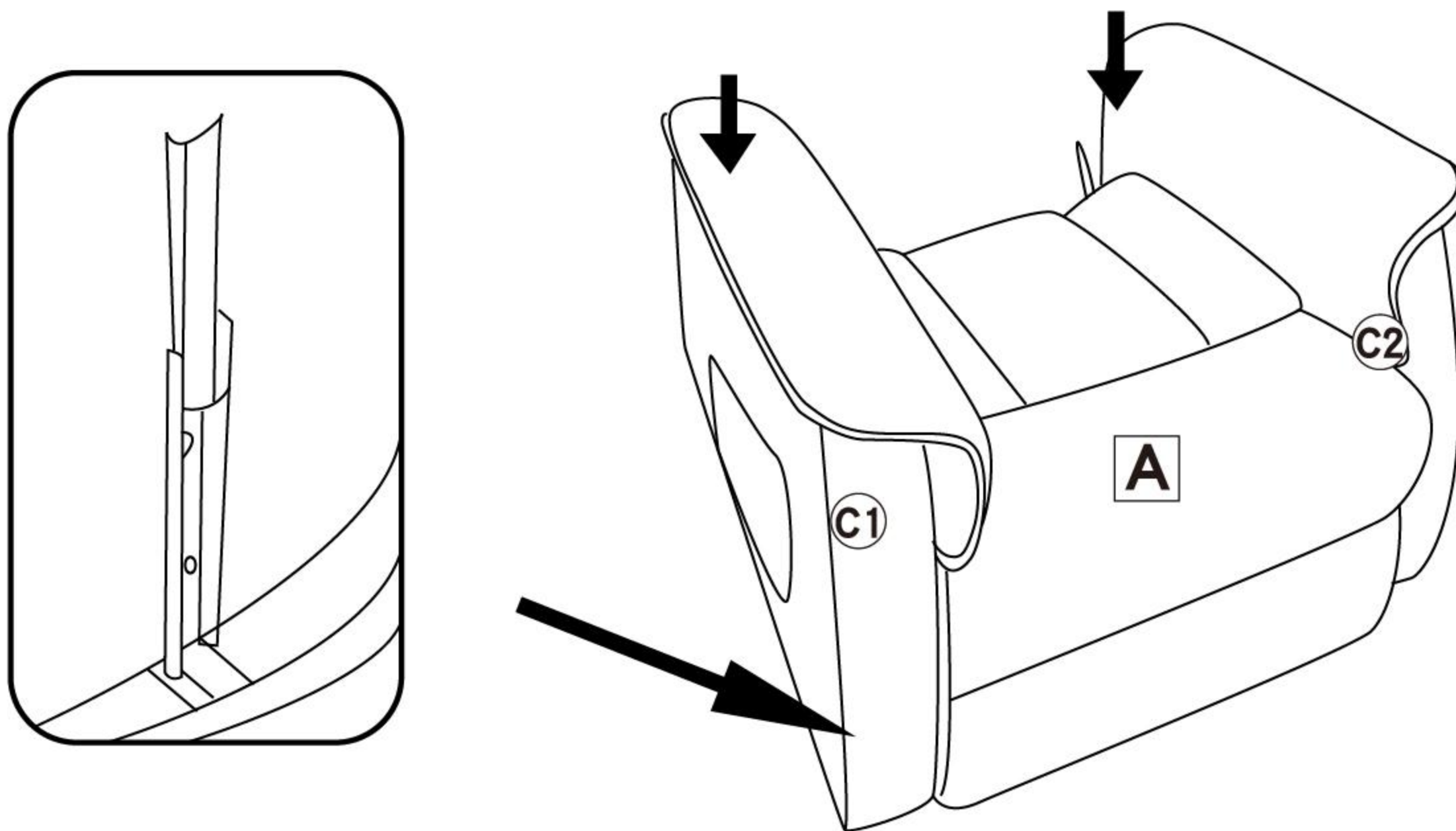

## Step2

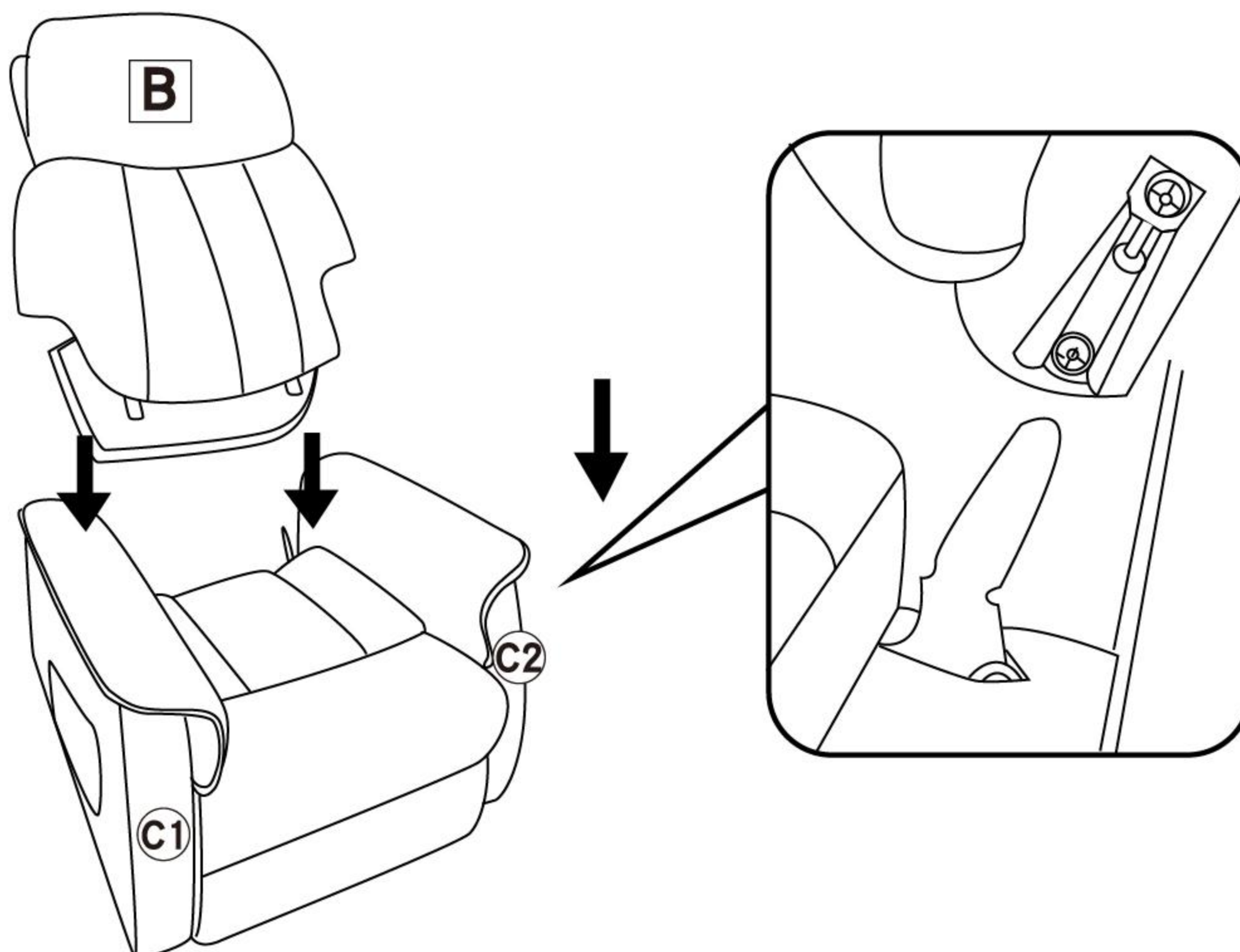

# Sofa assembly instruction

## Step3

The USB socket in the bottom of the sofa armrest.

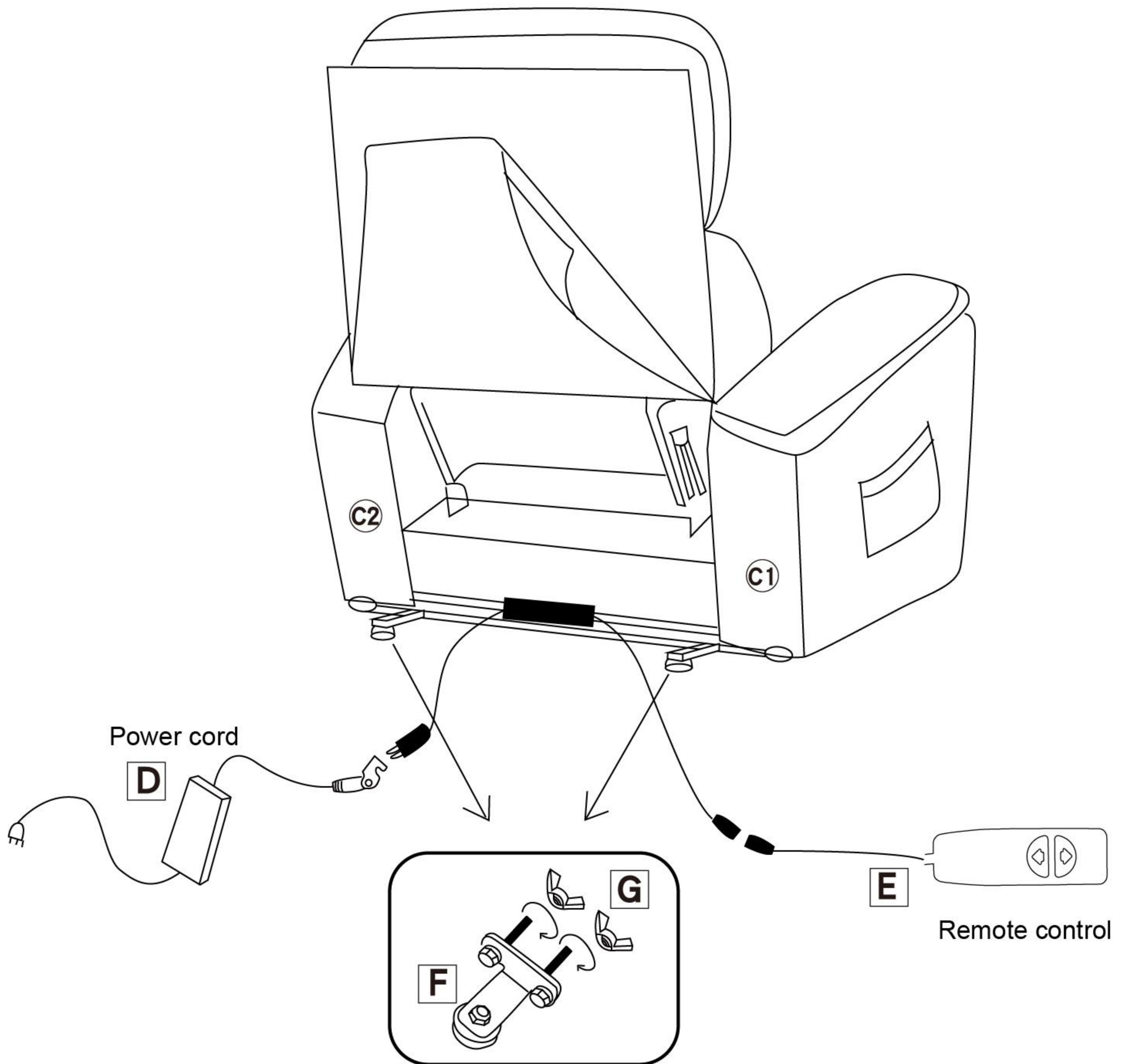



# Sofa assembly instruction

How to reline?

Press

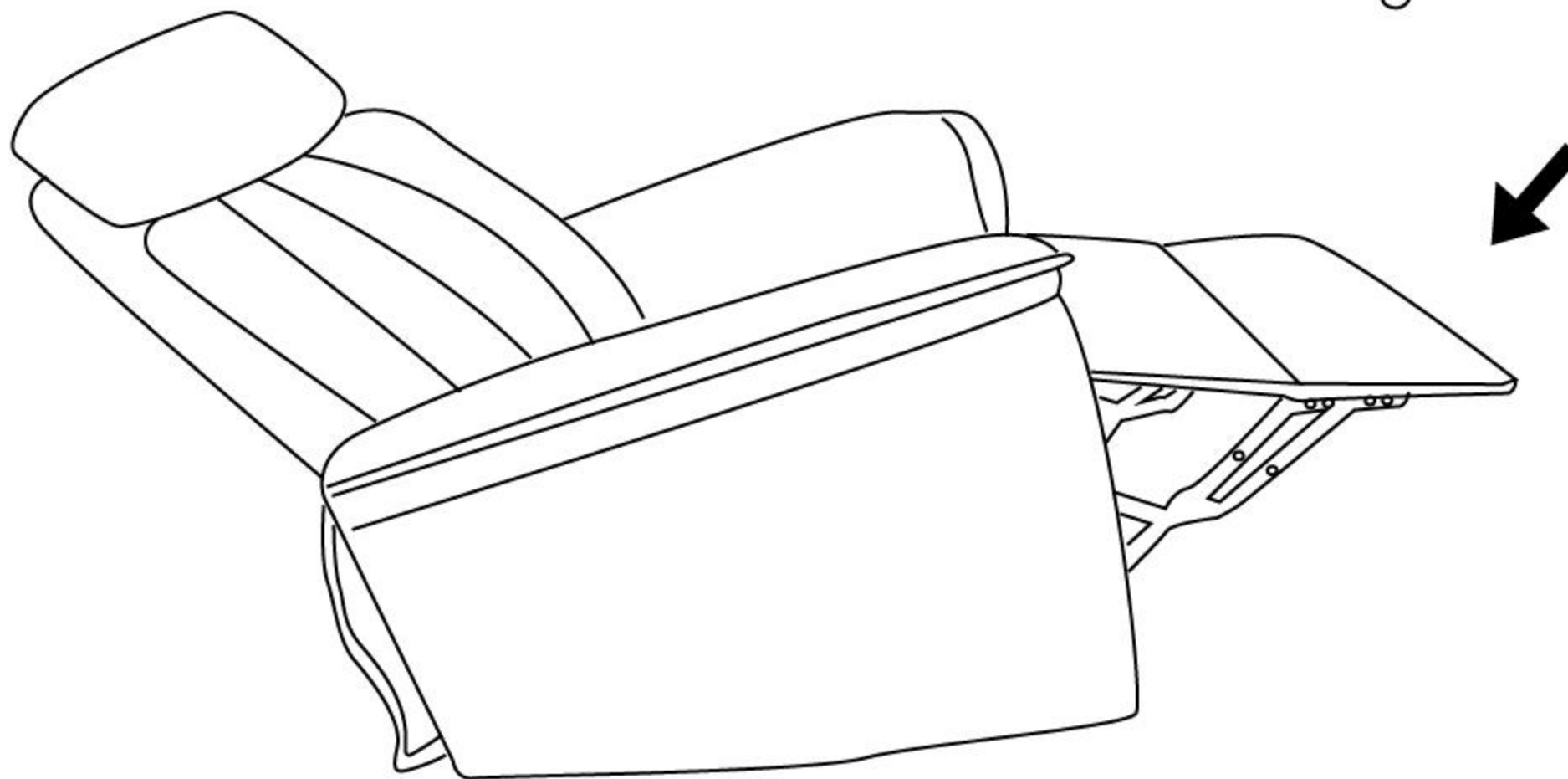
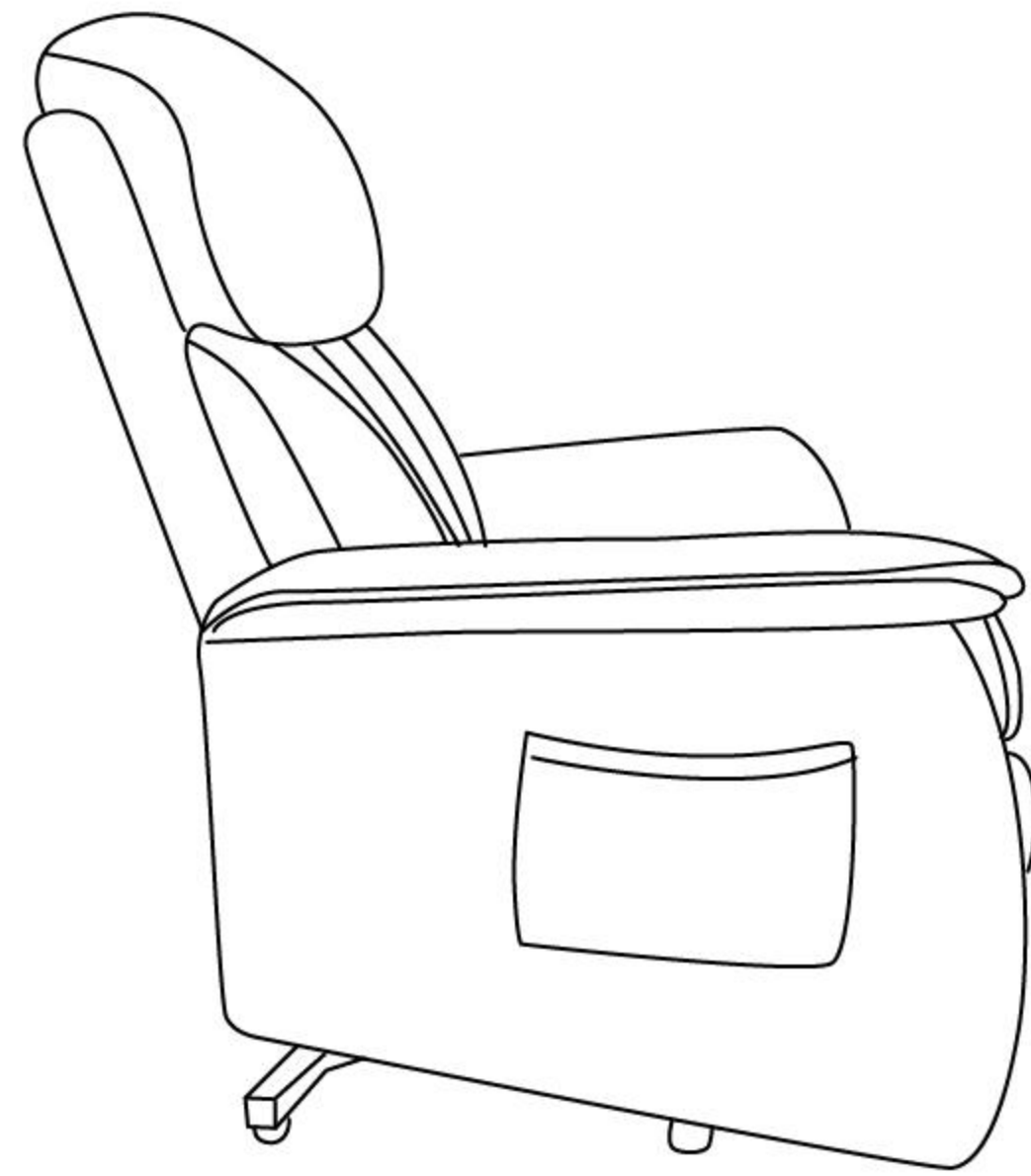
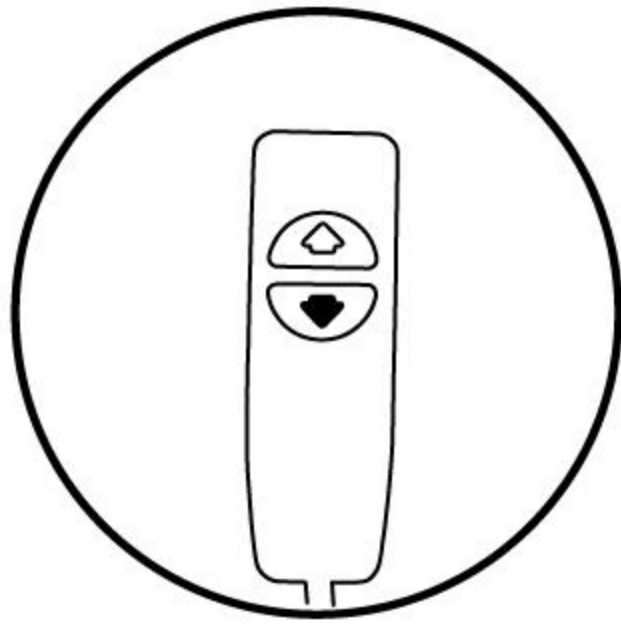

How to get footrest latch down an stand?

Press

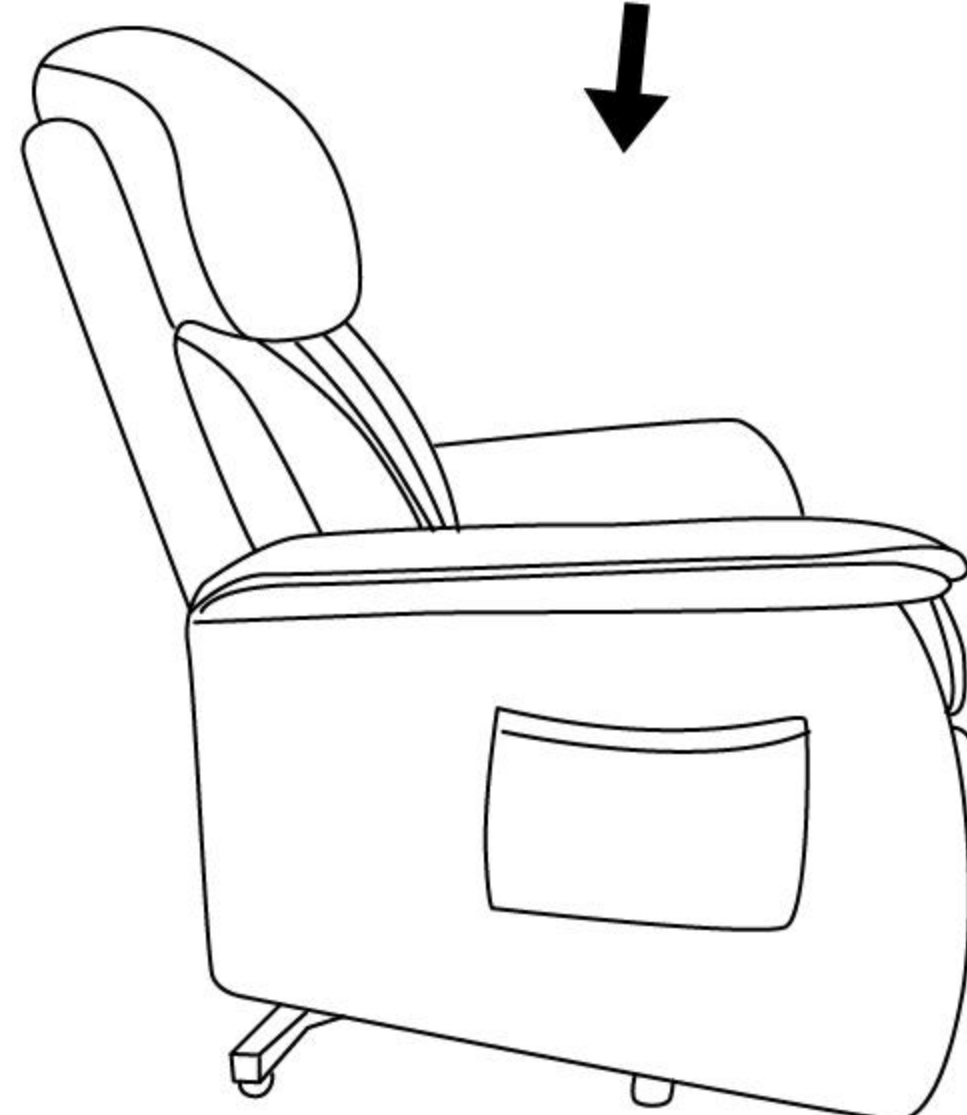
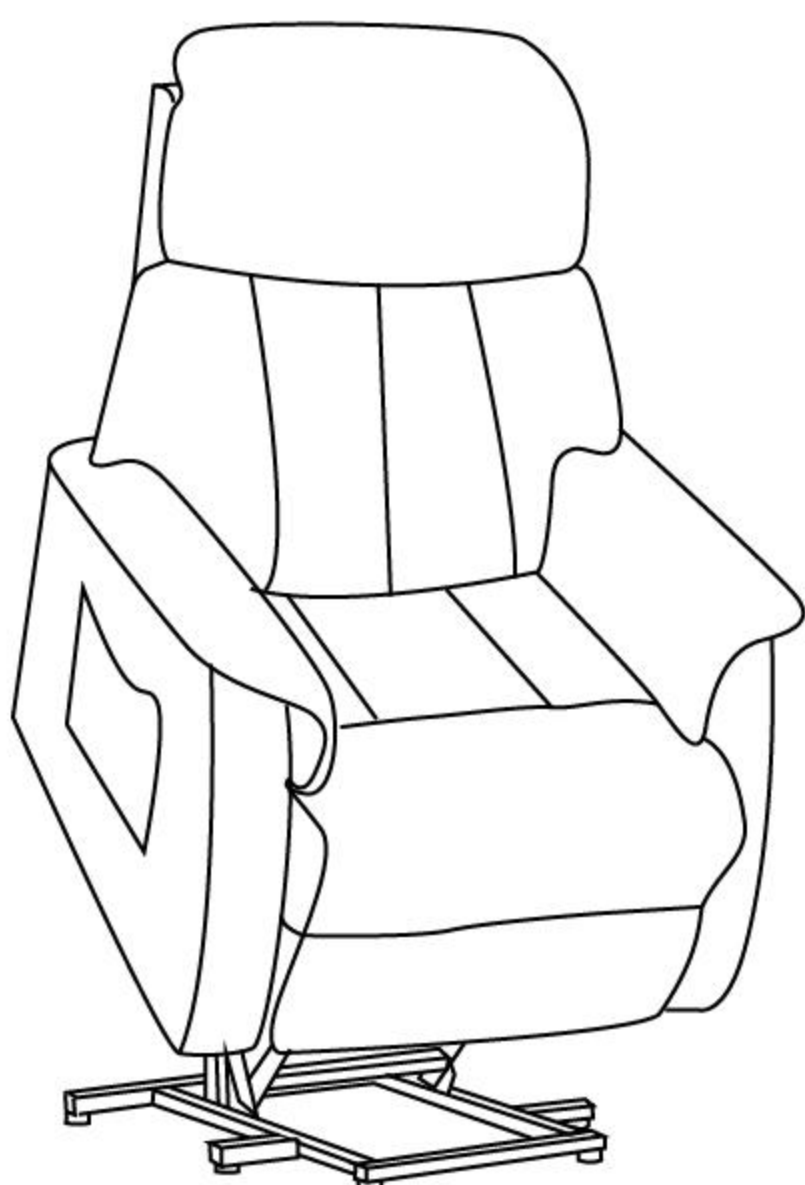
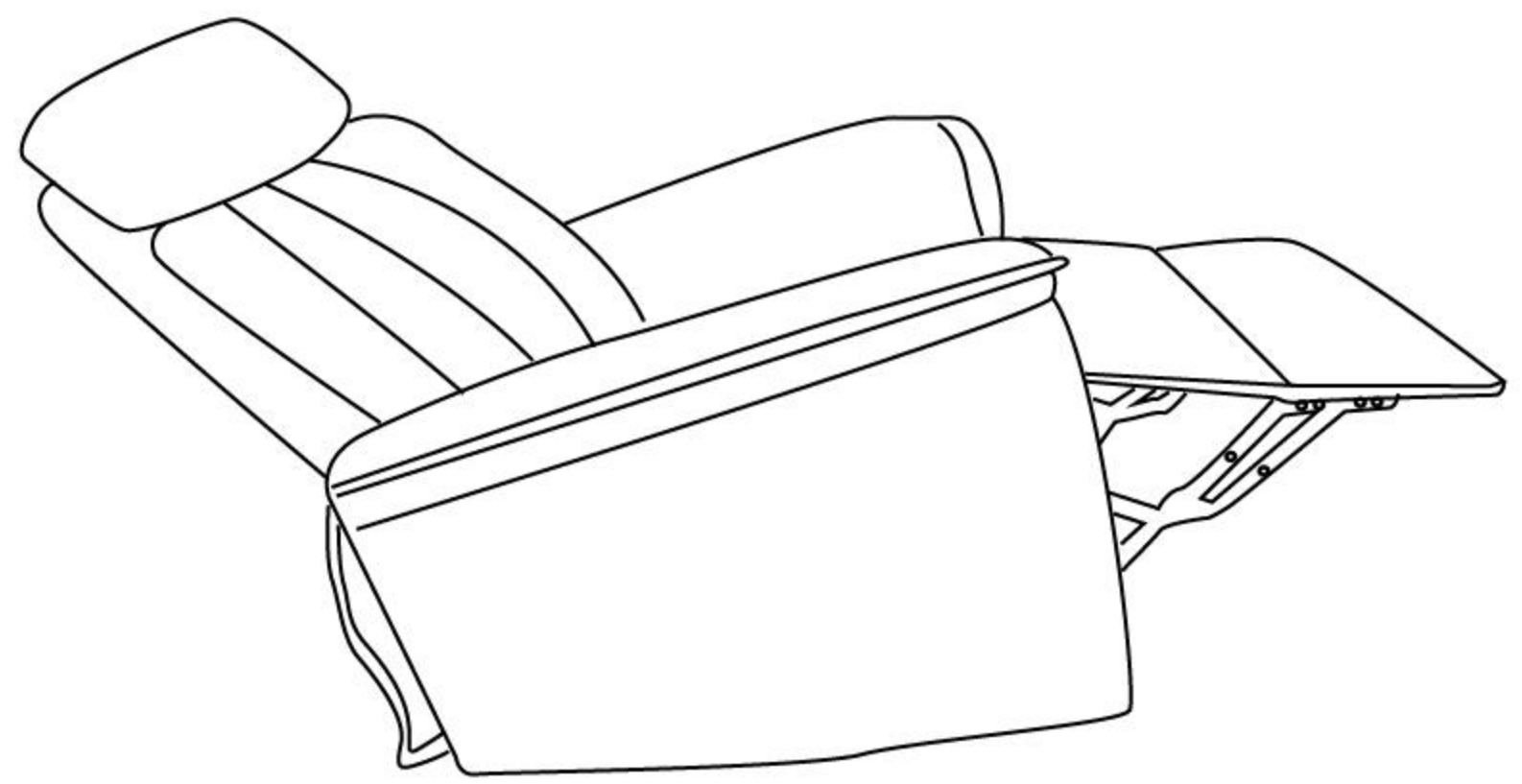
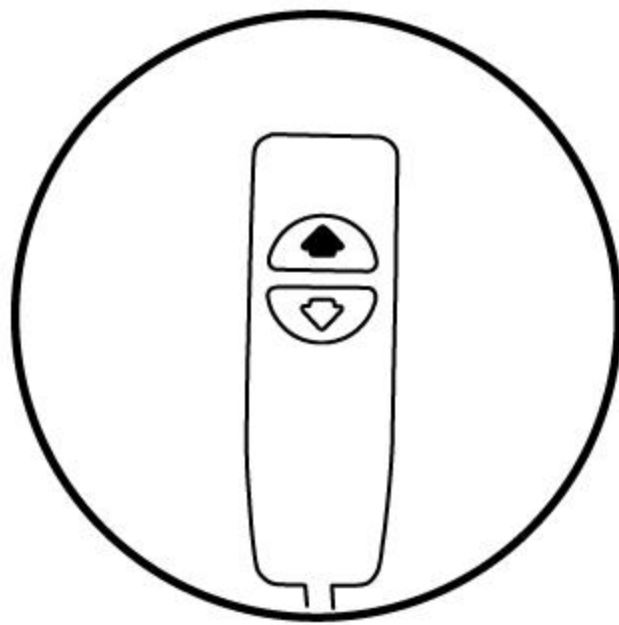

# Sofa assembly instruction

How to use the remote control for the standing-up aid?

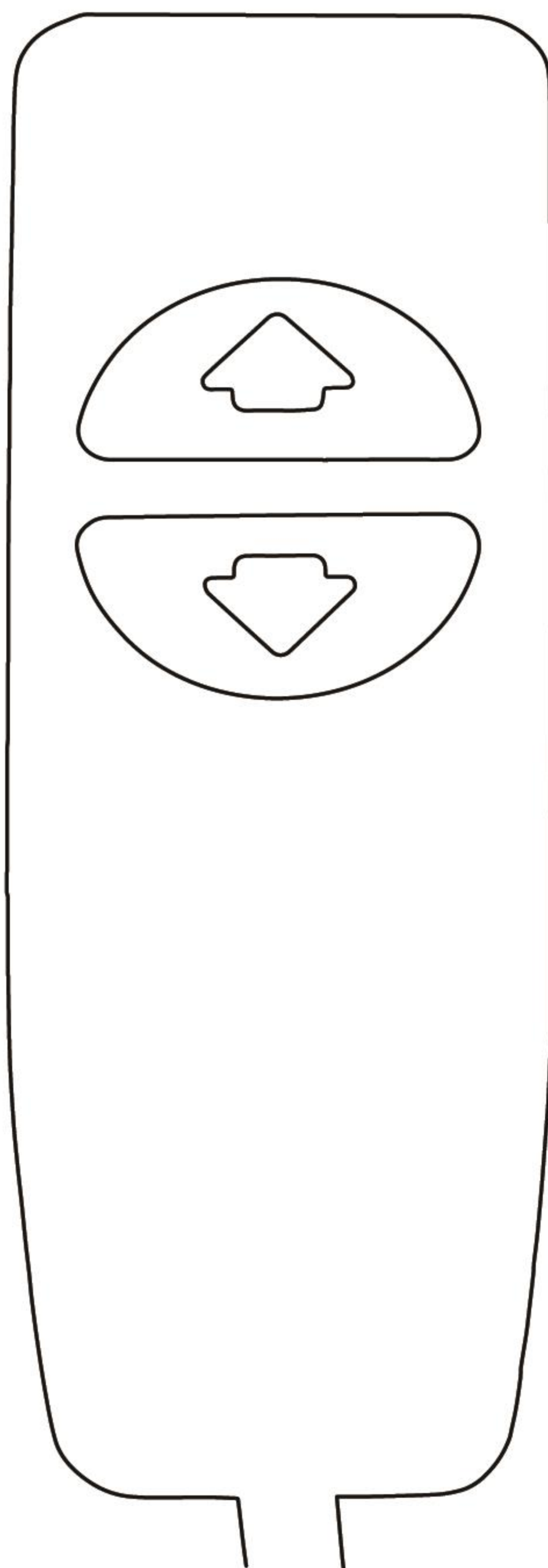



backrest straight, foot section down (sitting position);  
keep pressing: tilt the sofa forwards (stand-up aid).



Move the backrest down, the foot section up (lying position).

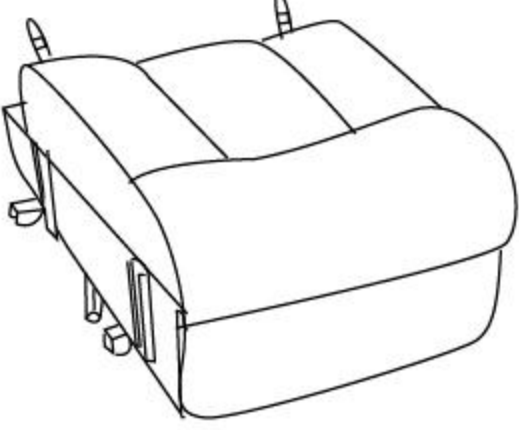
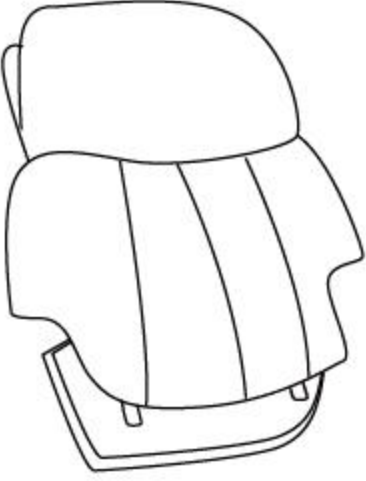
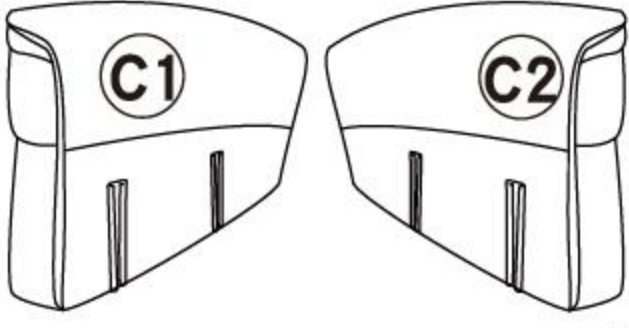
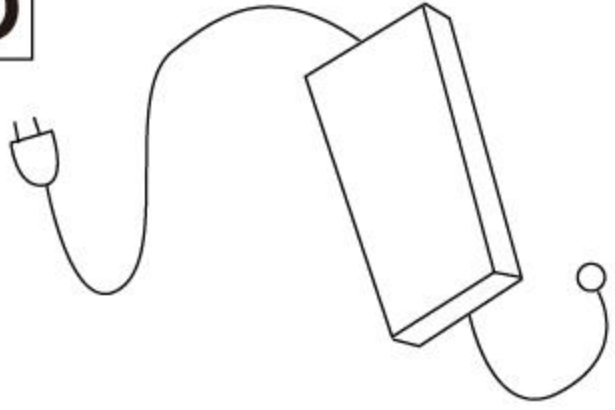

# Sofa assembly instruction

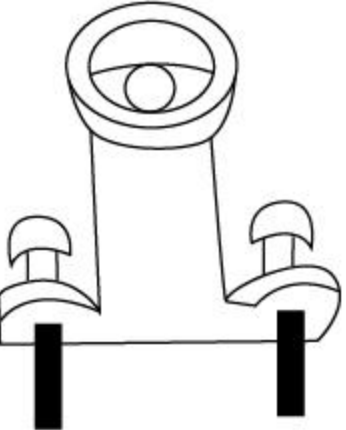
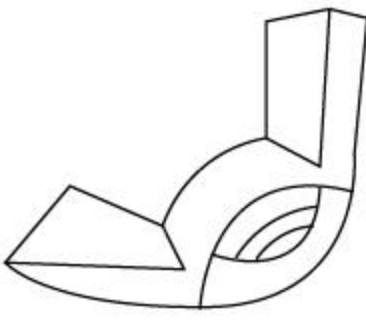
<b>A</b>  Sitzbasis 1x	<b>B</b>  Rückenlehne 1x	<b>C</b>  Armlehne links und rechts 2x	<b>D</b>  Netzteil 1x
<b>E</b>  Fernbedienung 1x	<b>F</b>  Teil 1 2x	<b>G</b>  Teil 2 4x	

## Schritt 1

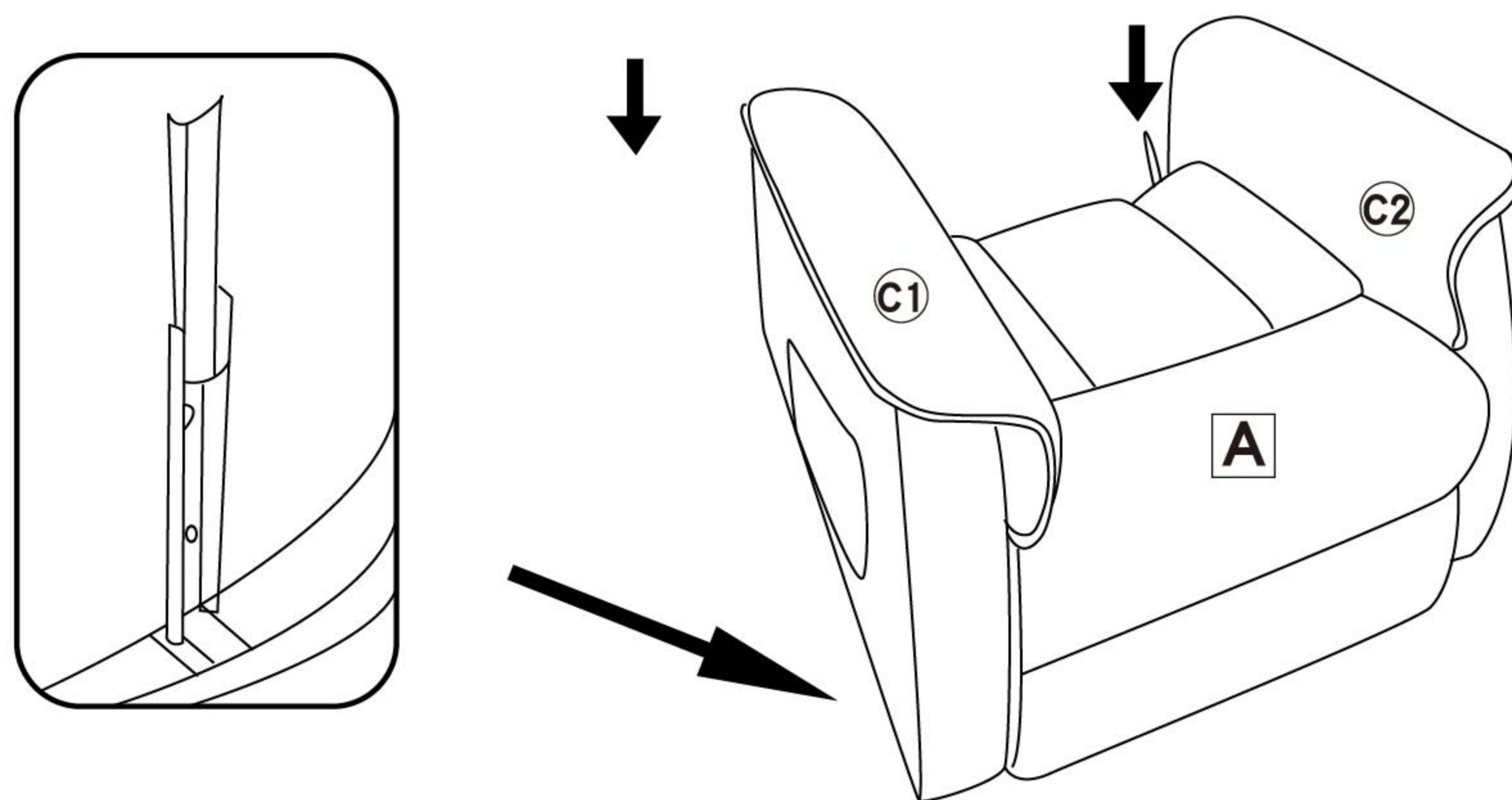

## Schritt 2

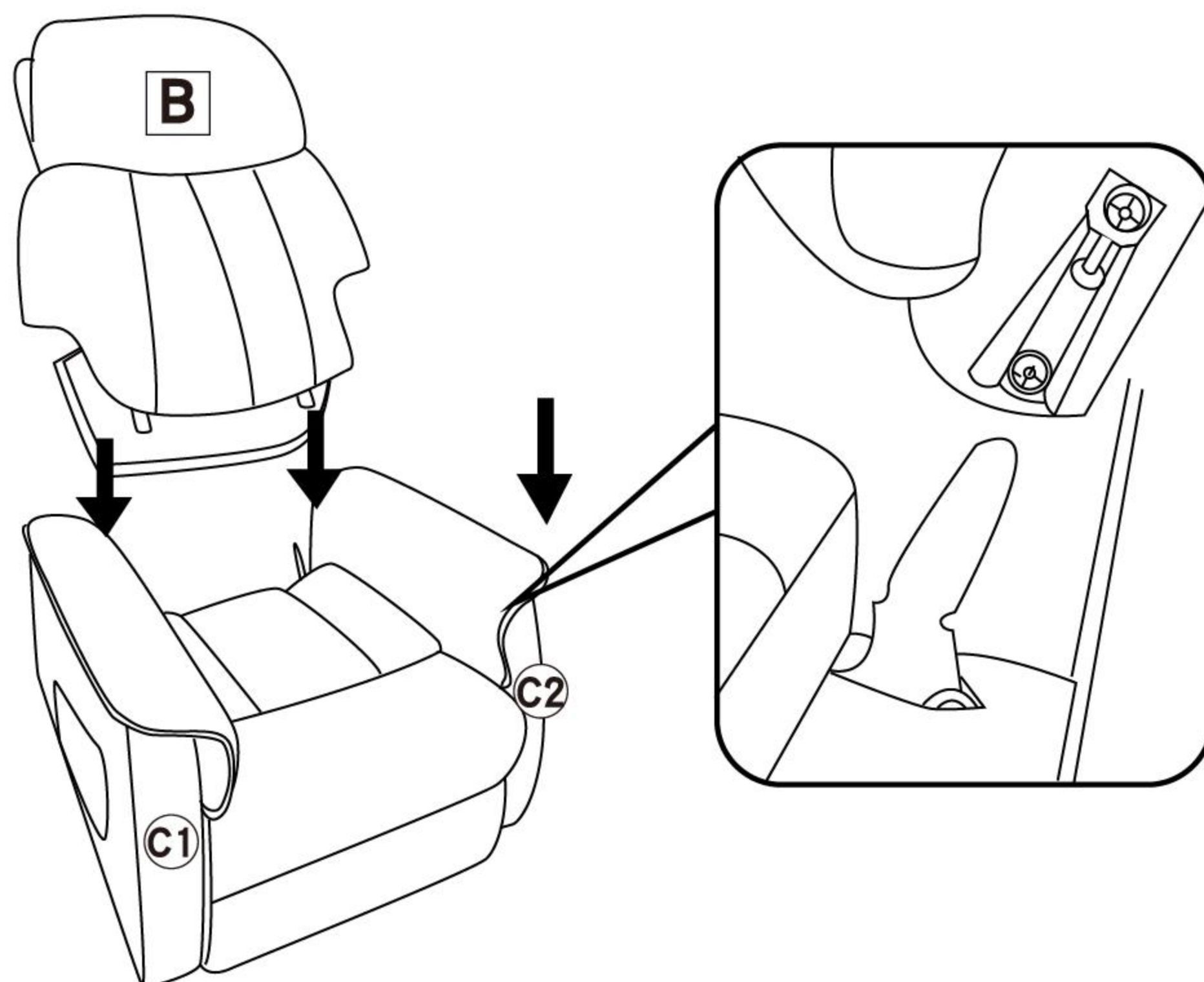

# Sofa assembly instruction

## Schritt 3

Die USB-Buchse befindet sich an der Unterseite der Armlehne.

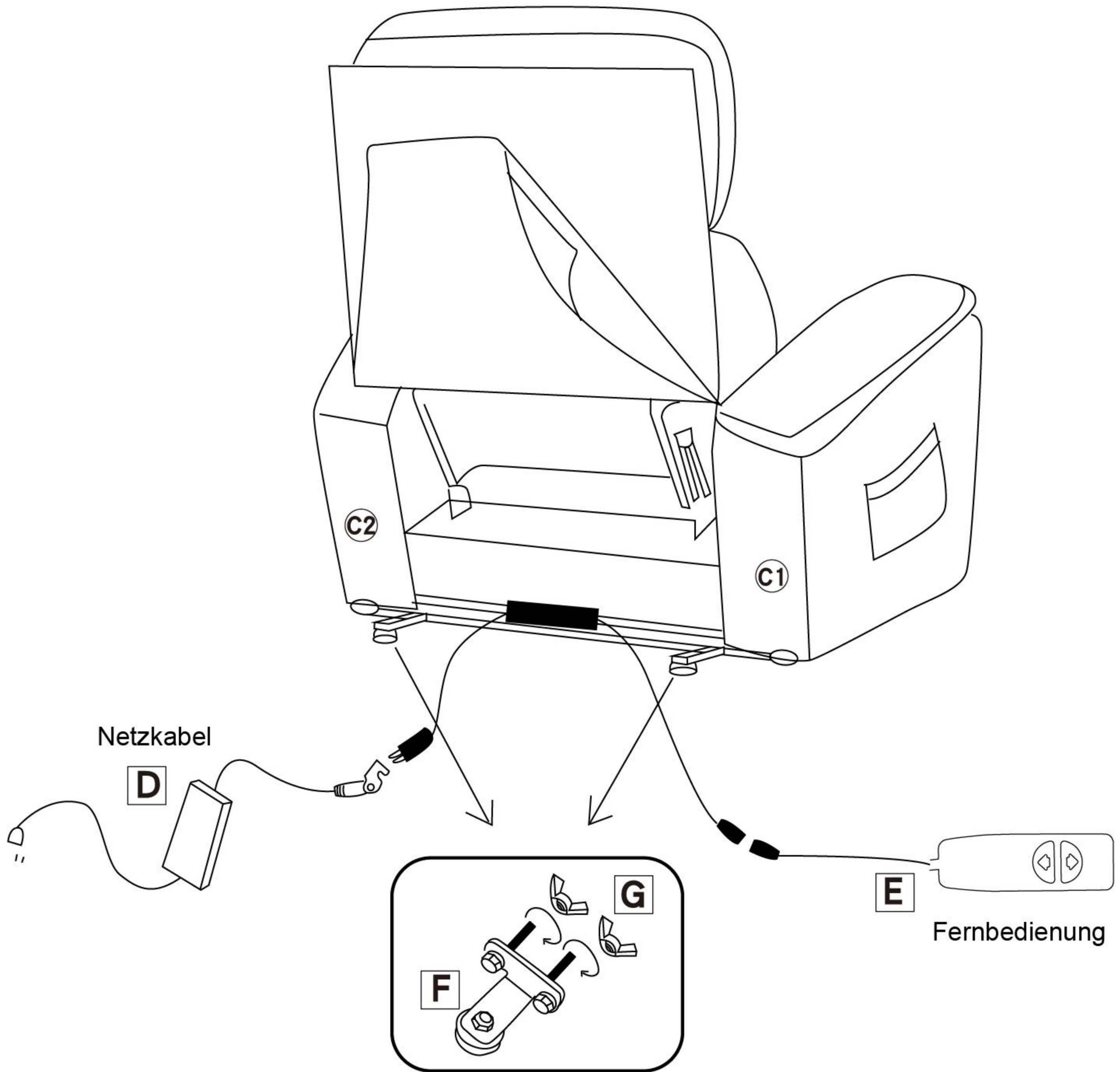



# Sofa assembly instruction

Wie man sich zurücklehnt?

Drücken

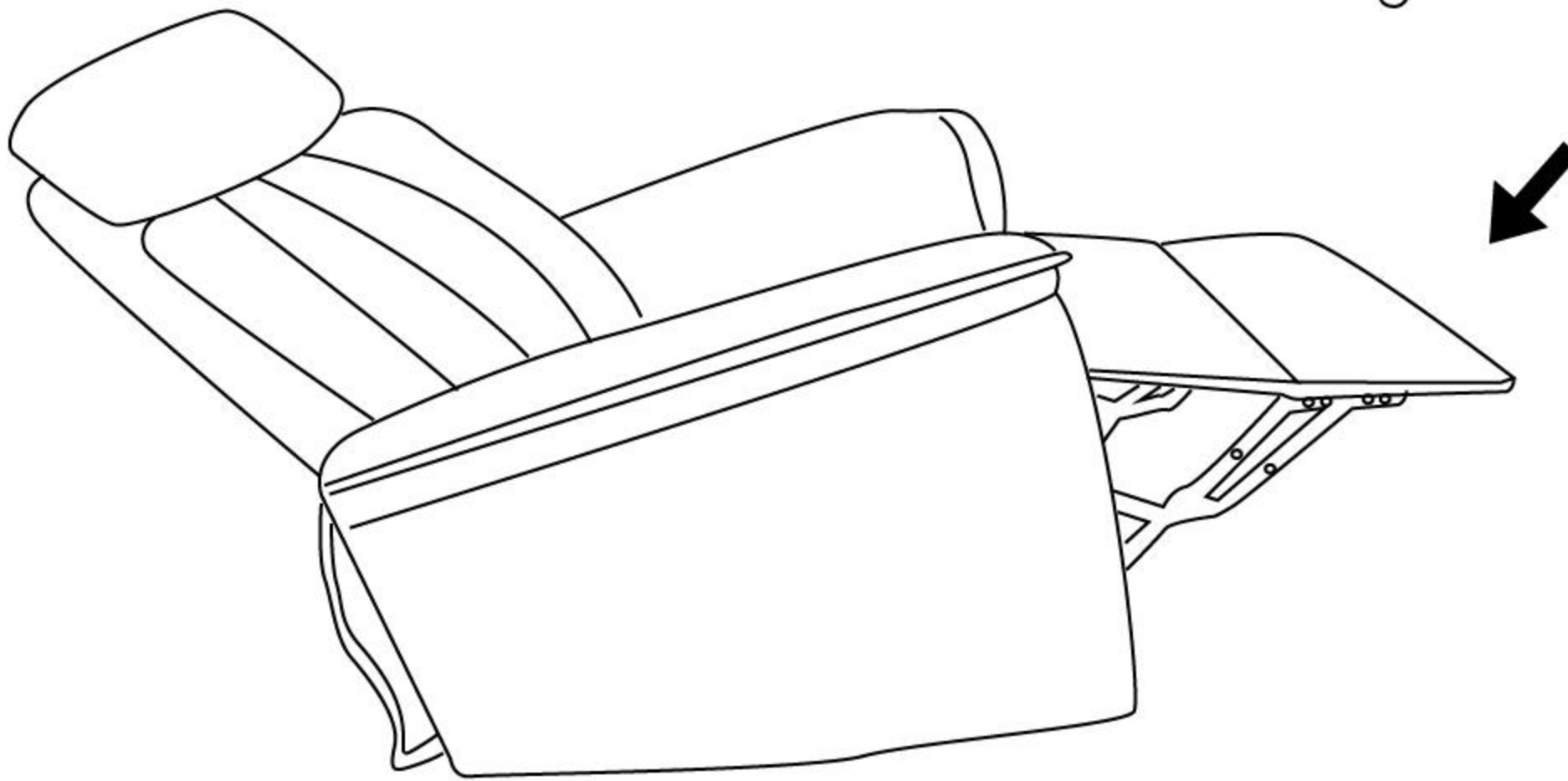
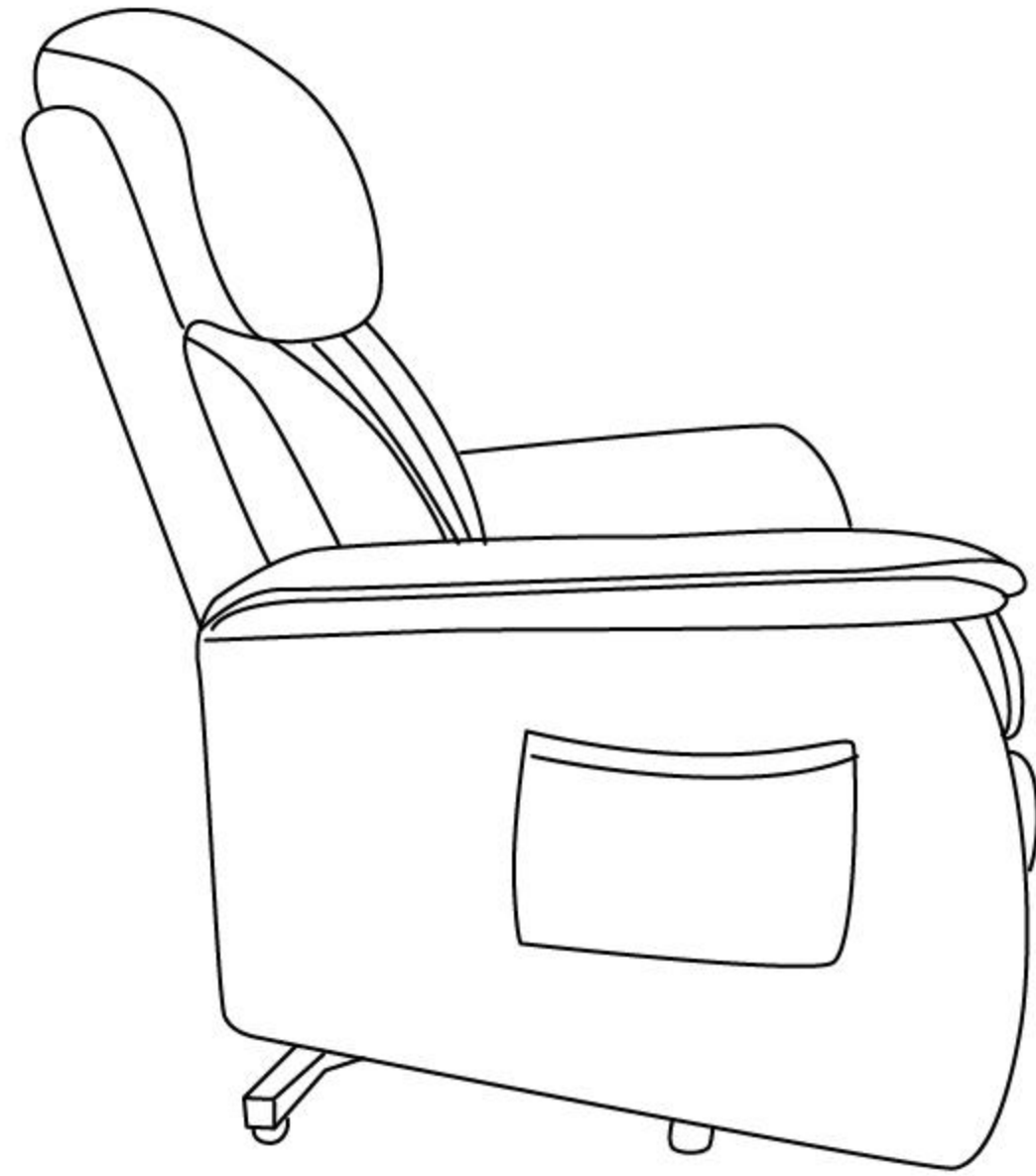
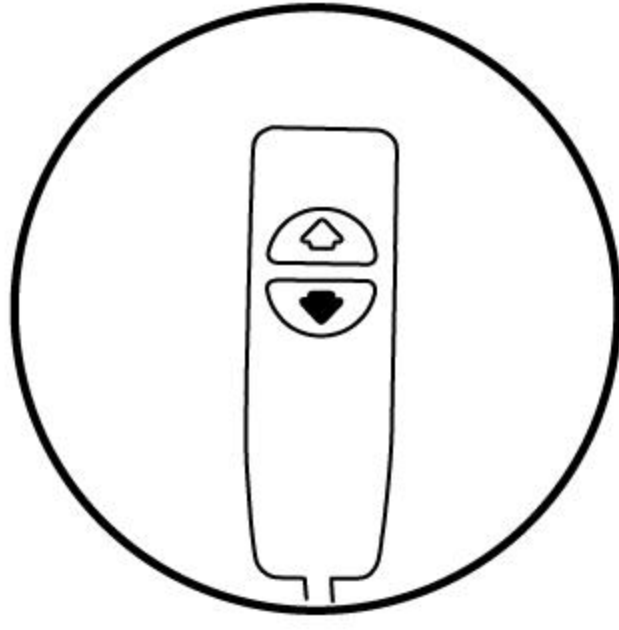

Wie man die Fußstütze einrastet lässt und steht?

Drücken

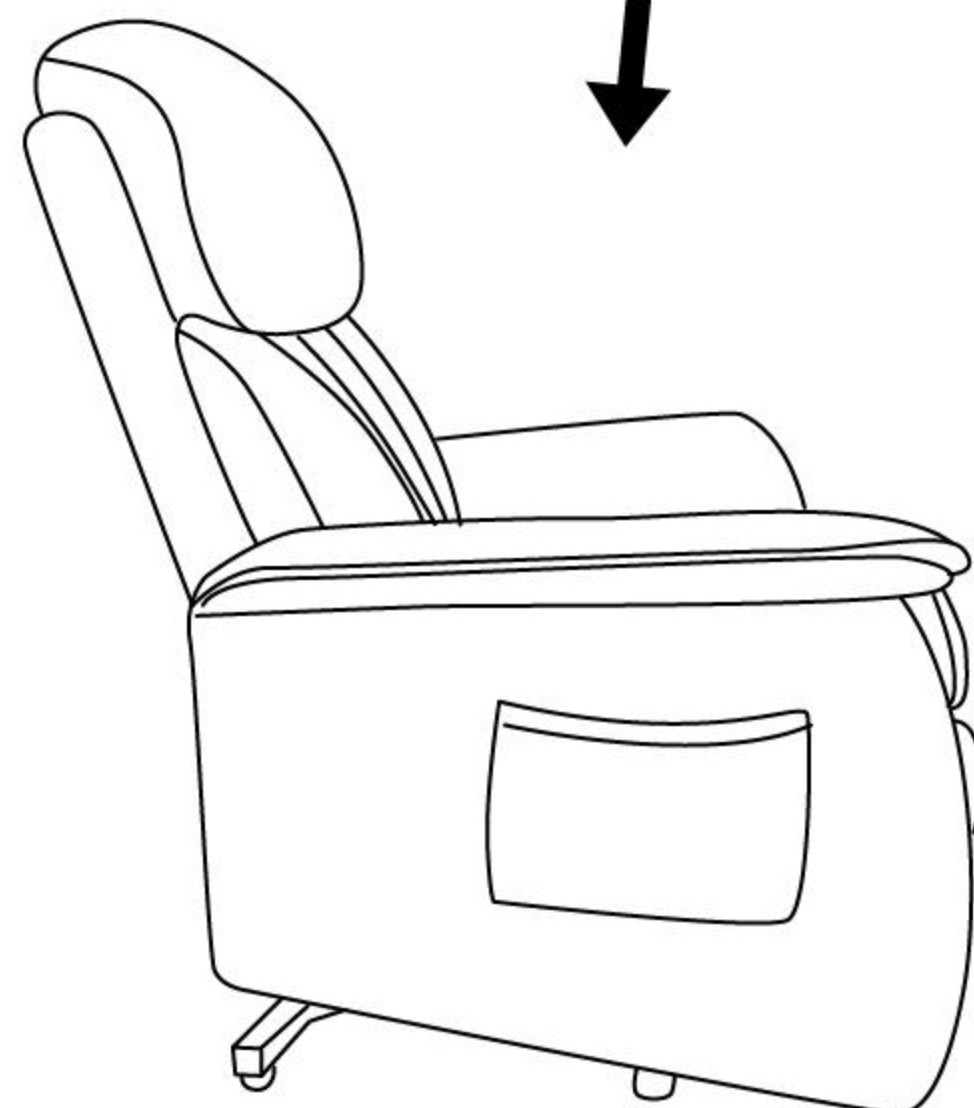
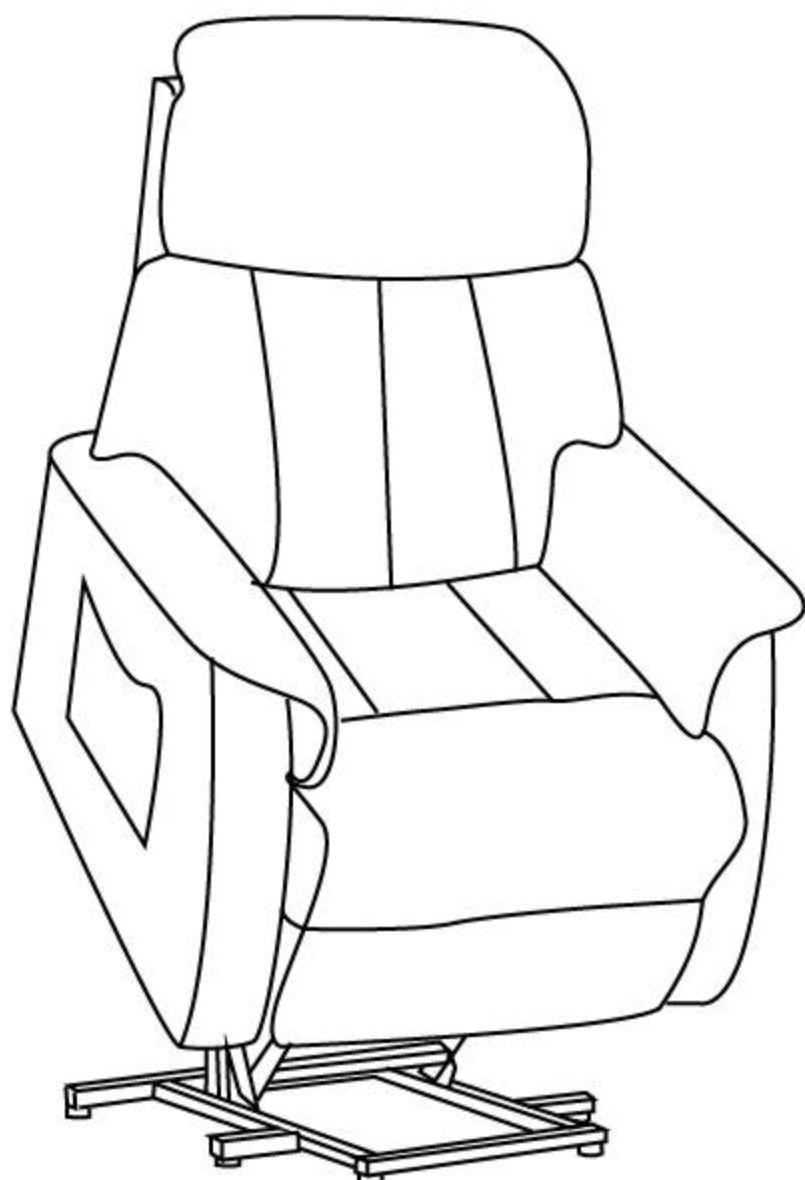
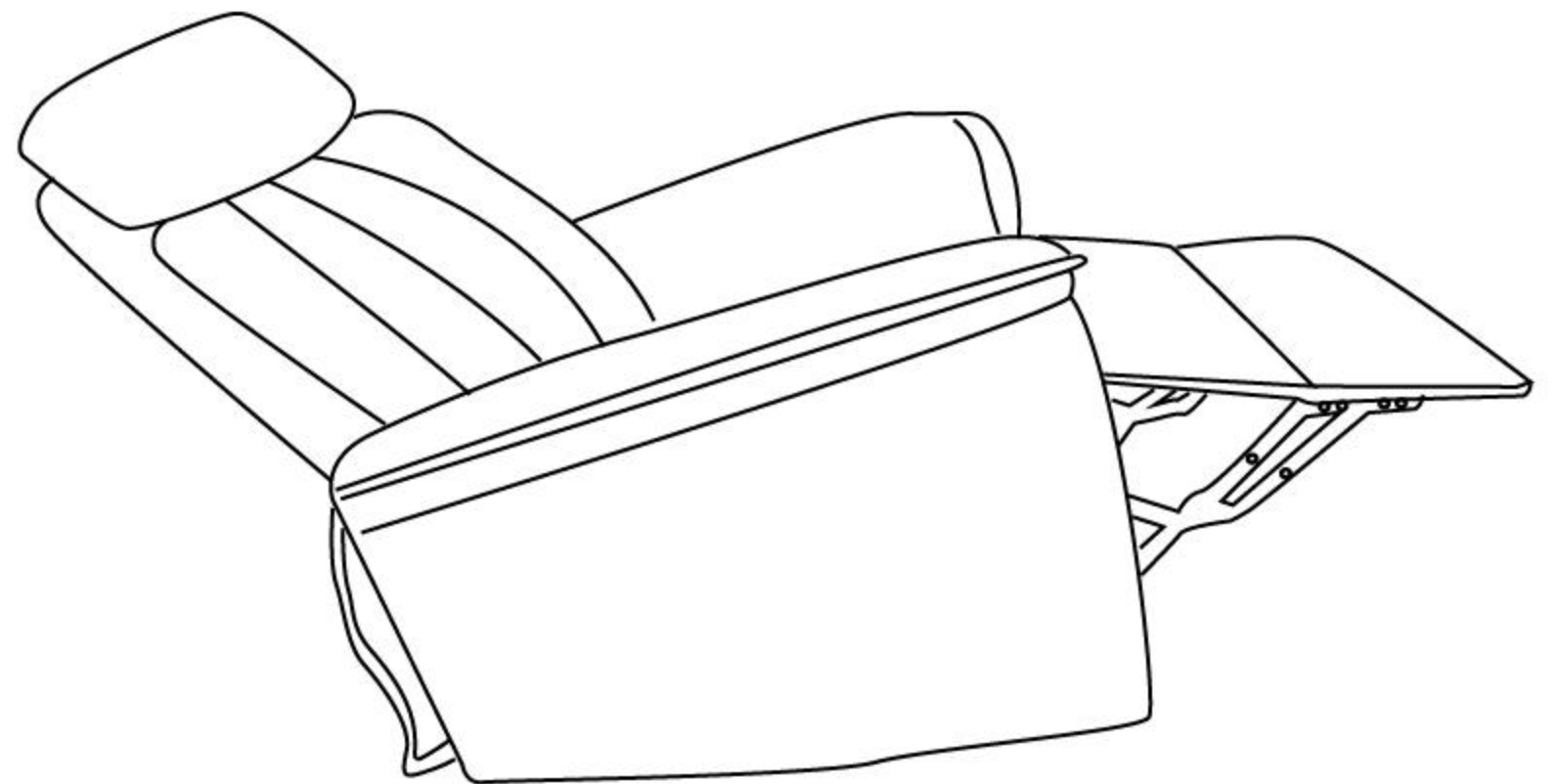
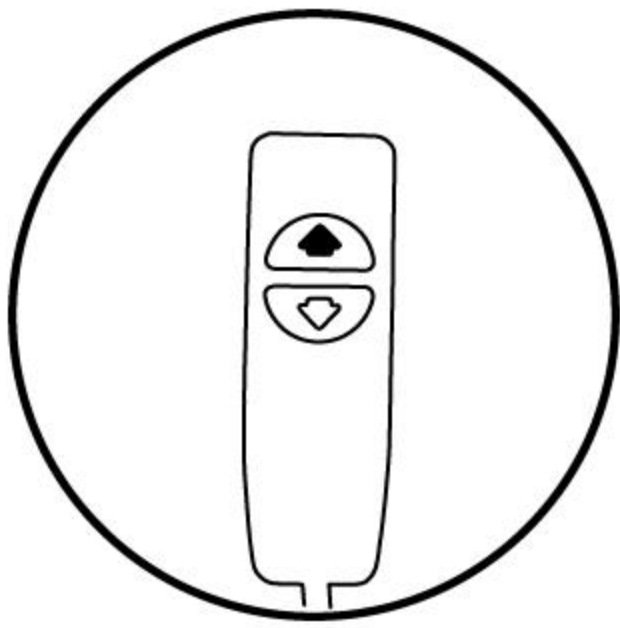



# Sofa assembly instruction

Wie benutzt man die Fernbedienung für die Aufstehhilfe?

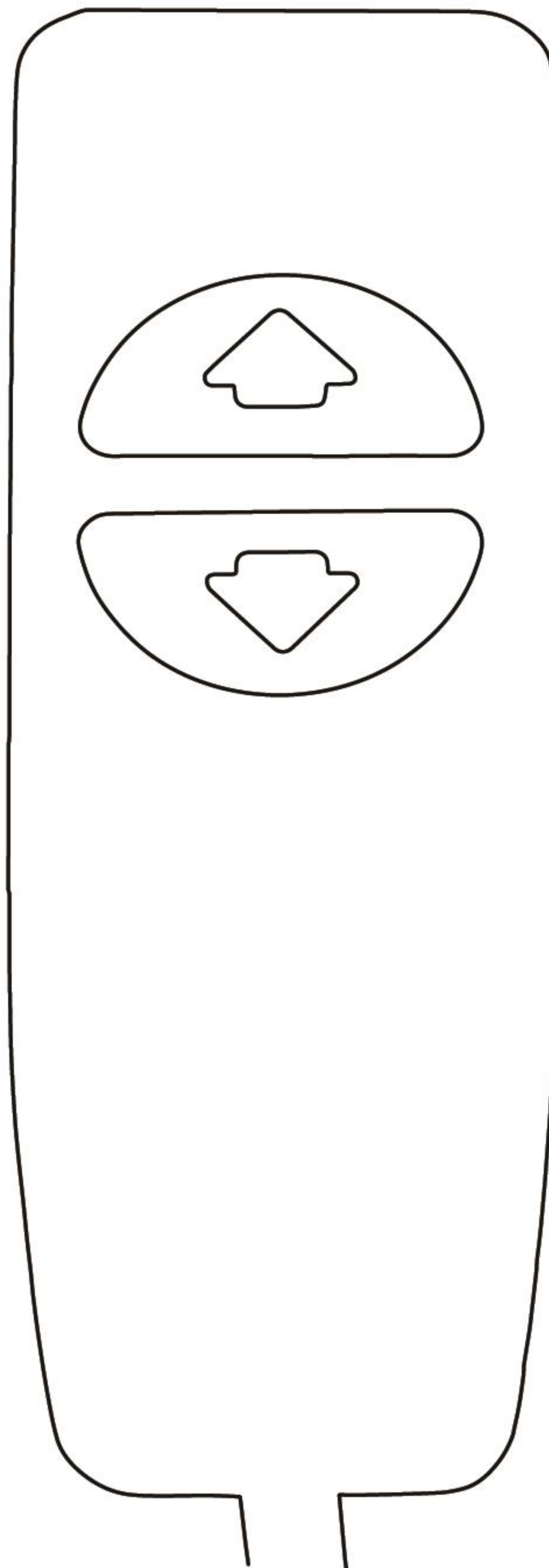

Rückenlehne gerade, Fußteil nach unten ( Sitzposition);  
weiter drücken: Sofa nach vorne neigen (Aufstehhilfe).



Rückenlehne nach unten, Fußteil nach oben stellen (Liegeposition)

# Sofa assembly instruction

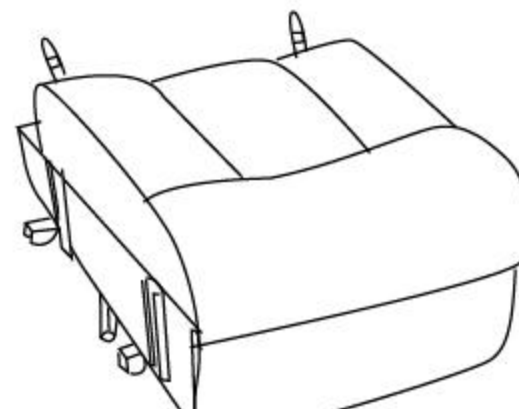
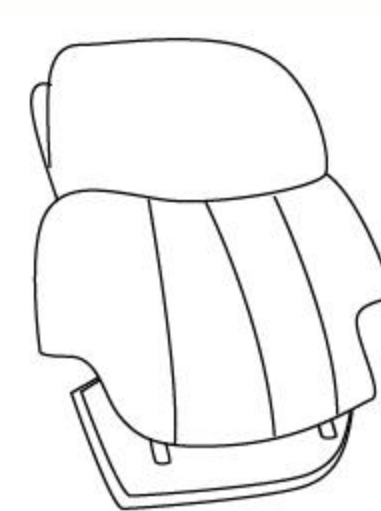
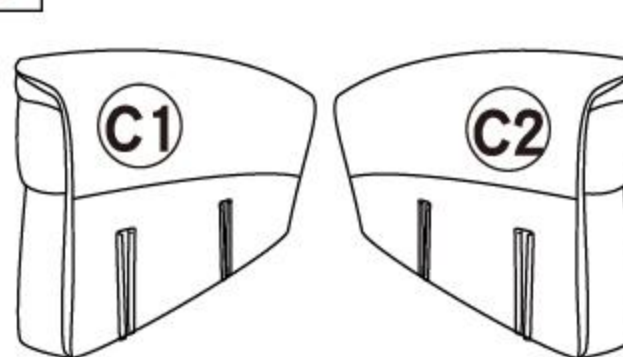
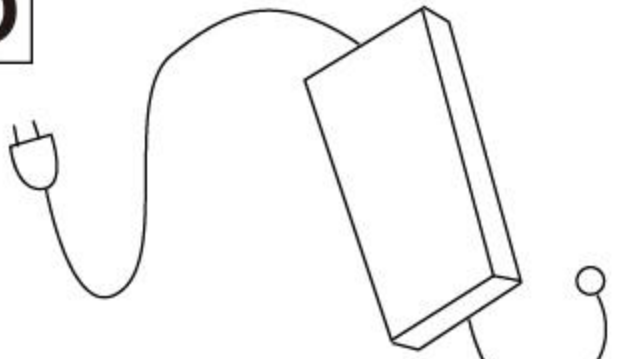
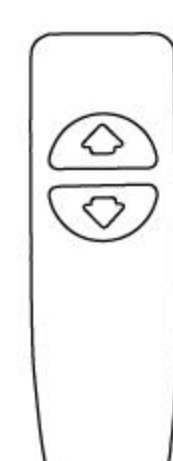
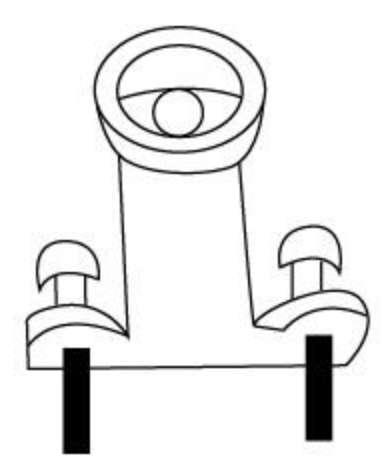
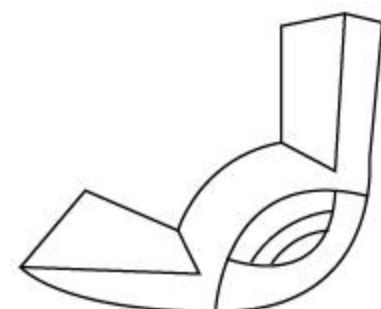
<b>A</b>  Base de la présidence 1x	<b>B</b>  Dossier 1x	<b>C</b>  Accoudoir gauche et droit 2x	<b>D</b>  Cordon d'alimentation 1x
<b>E</b>  Télécommande 1x	<b>F</b>  Partie1 2x	<b>G</b>  Partie2 4x	

## Étape 1

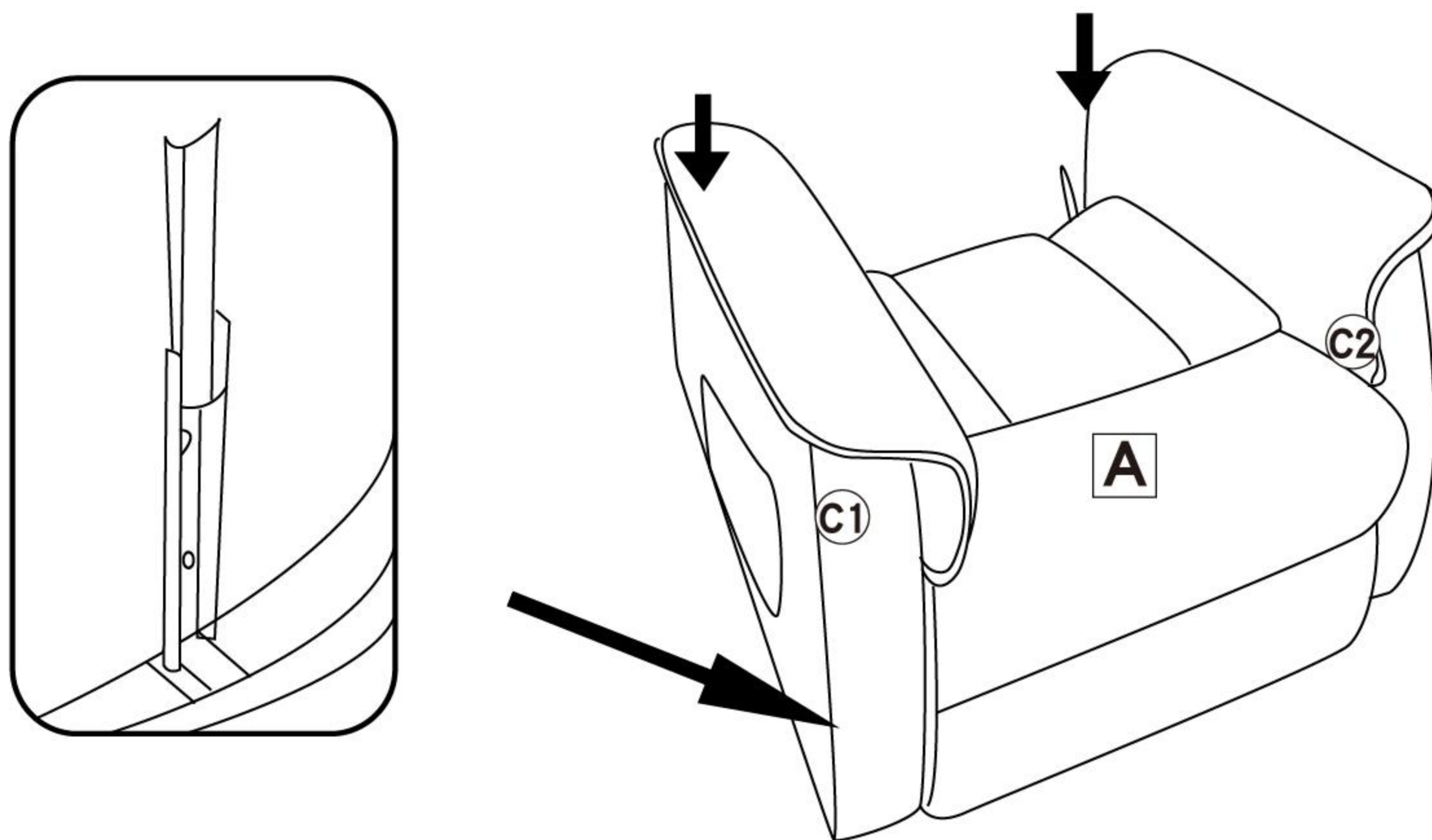

## Étape 2

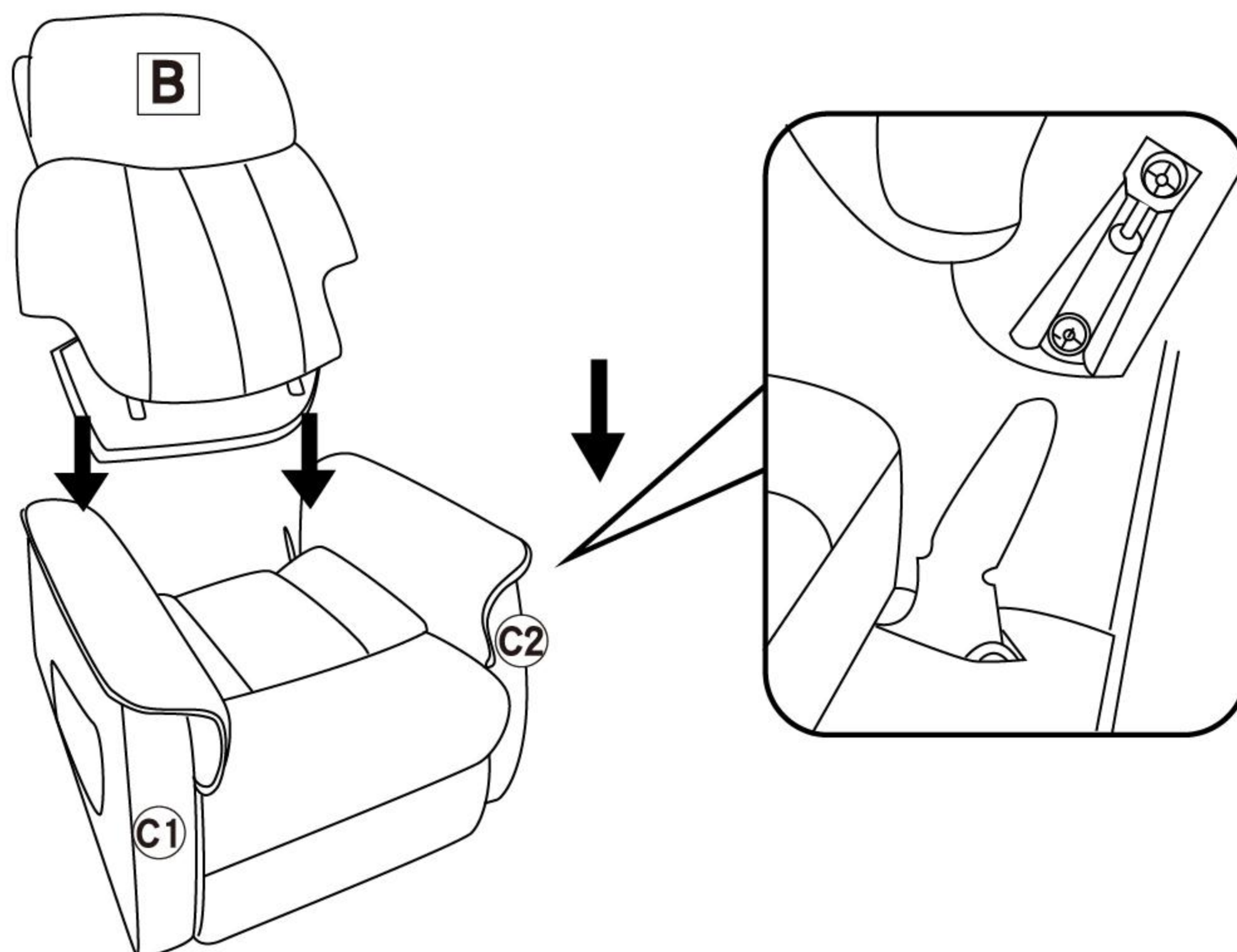



# Sofa assembly instruction

## Étape 3

La prise USB au bas de l'accoudoir du canapé.

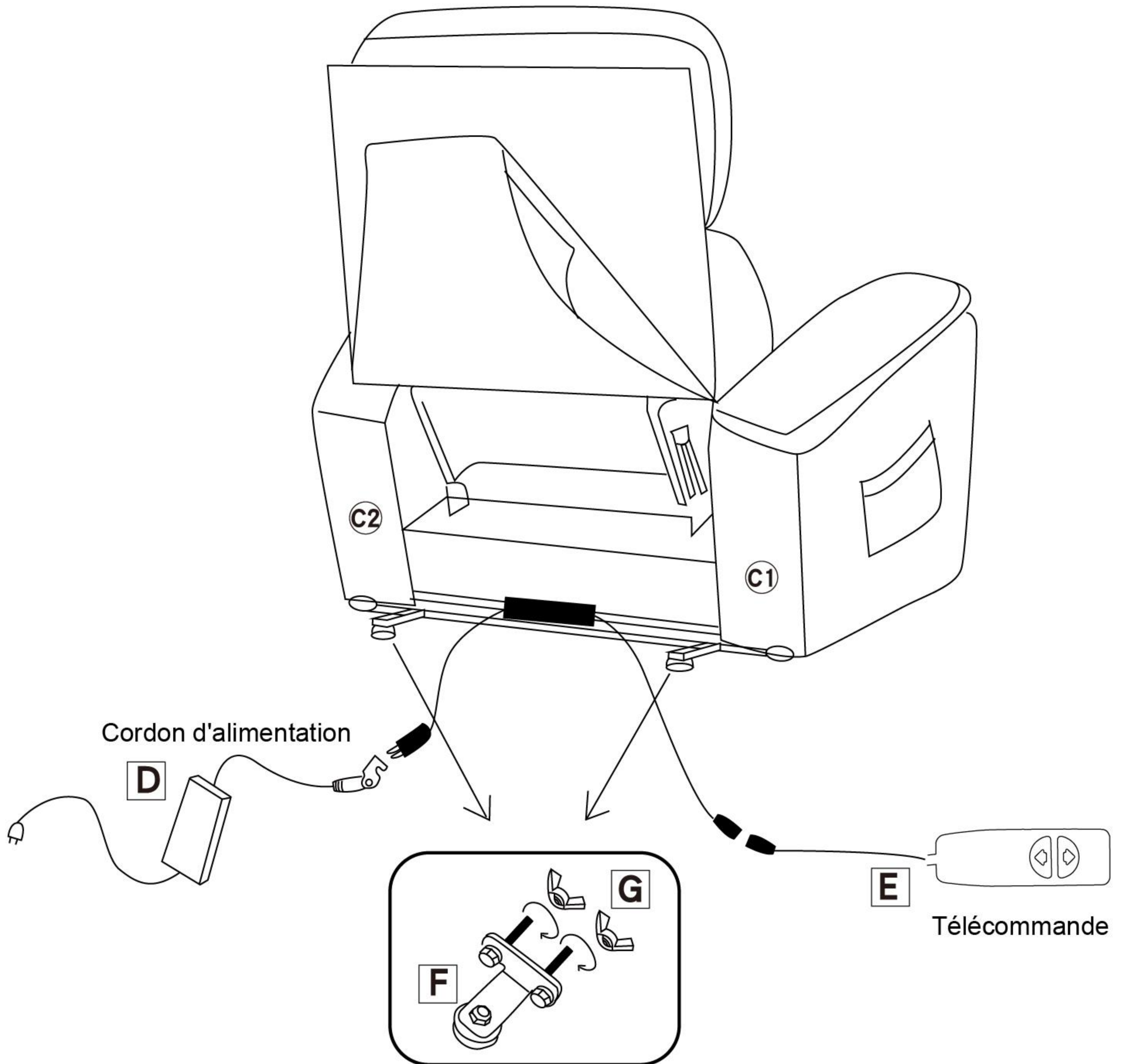

# Sofa assembly instruction

Comment recharger?

Presse

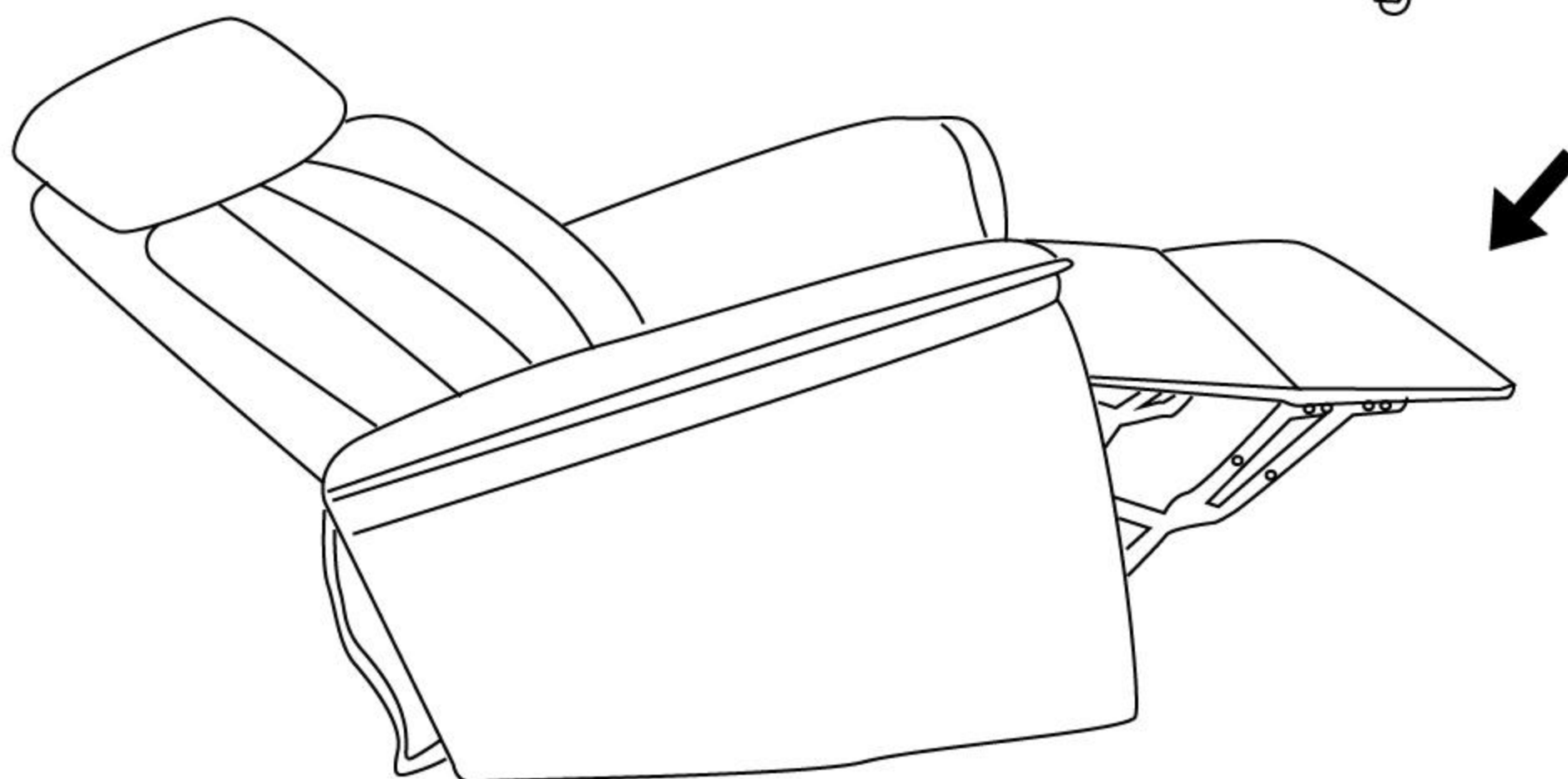
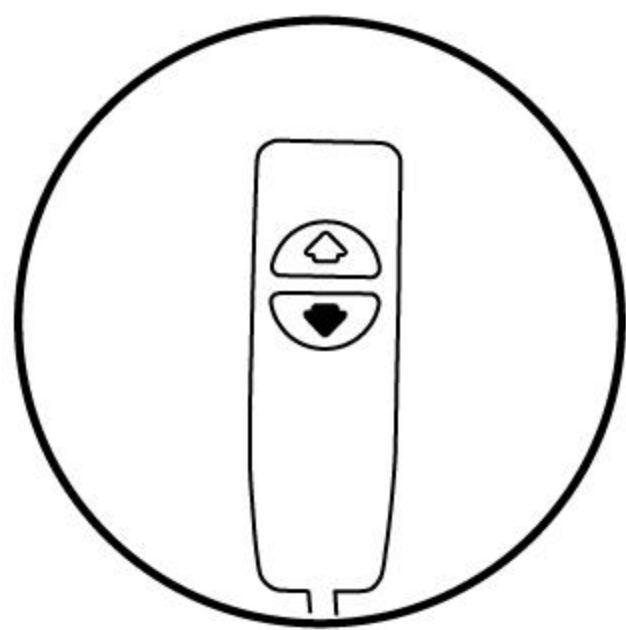

Comment faire pour que le repose-pied se verrouille sur un support?

Press

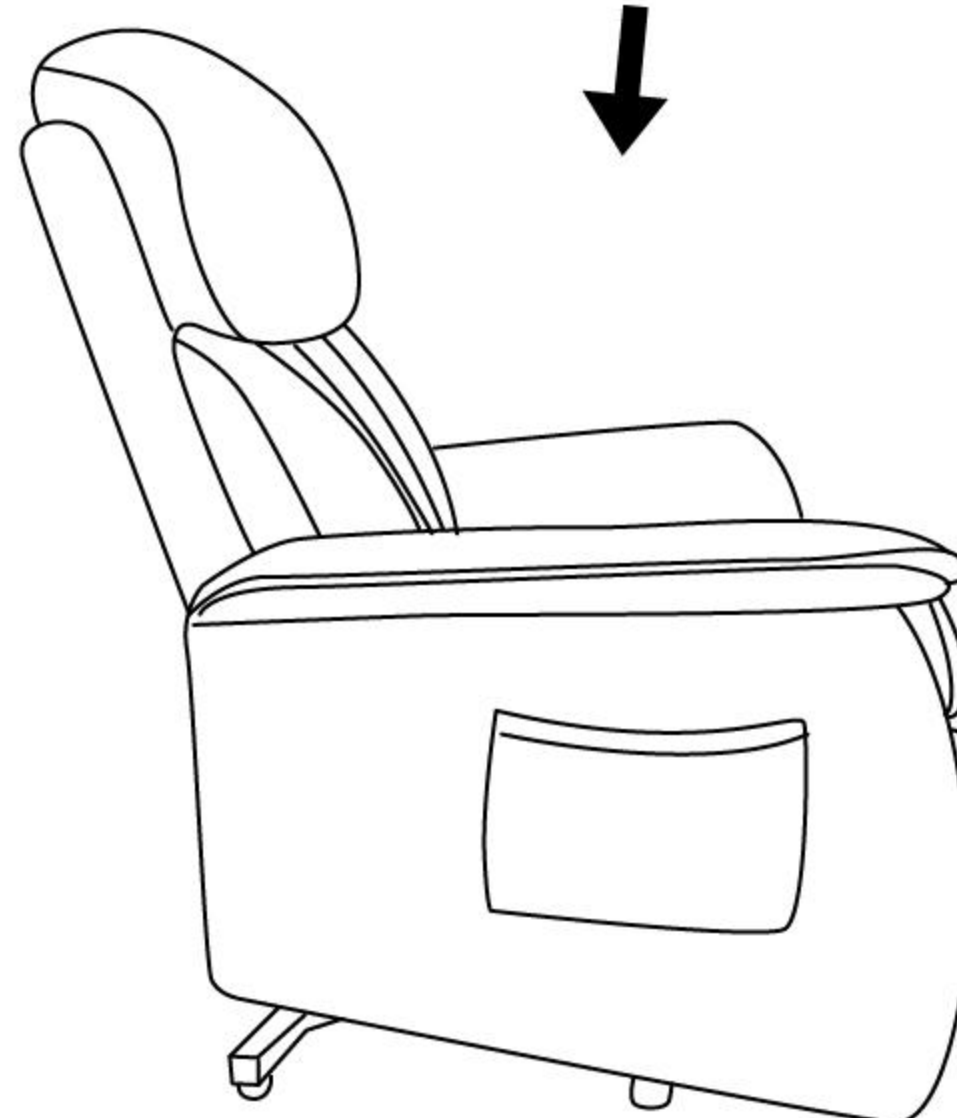
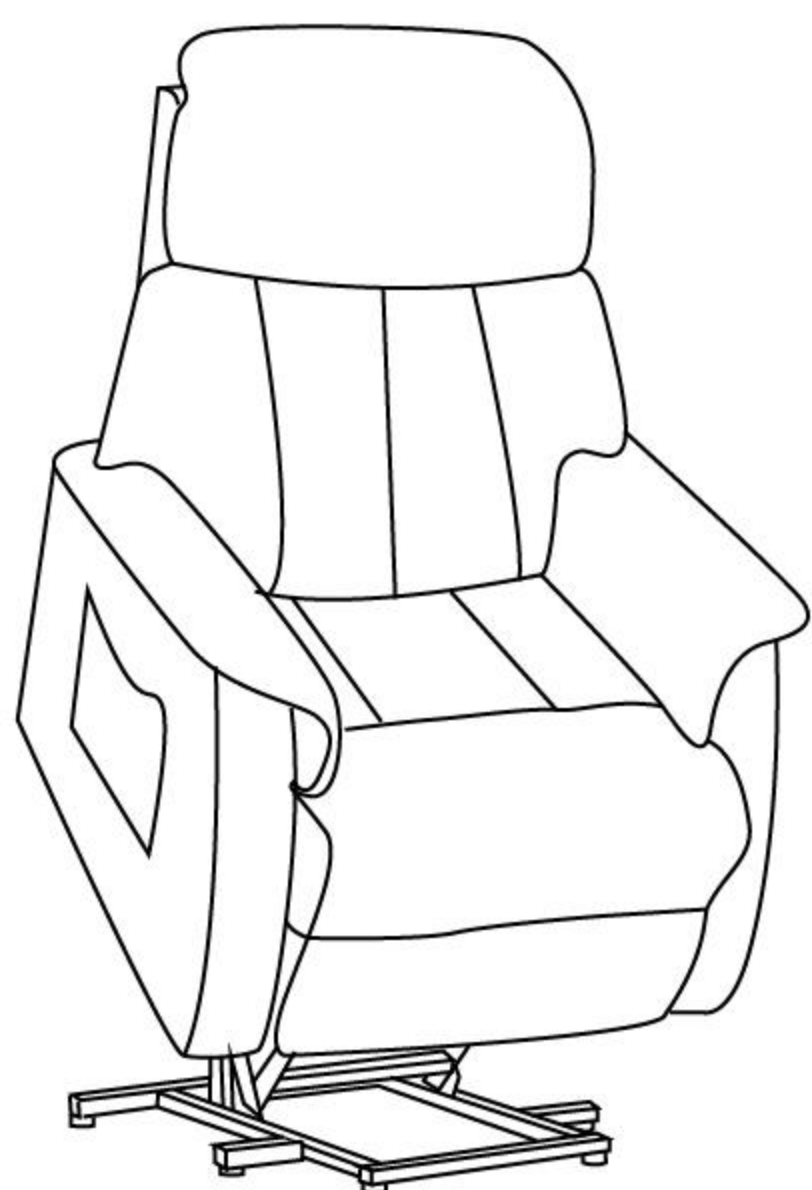
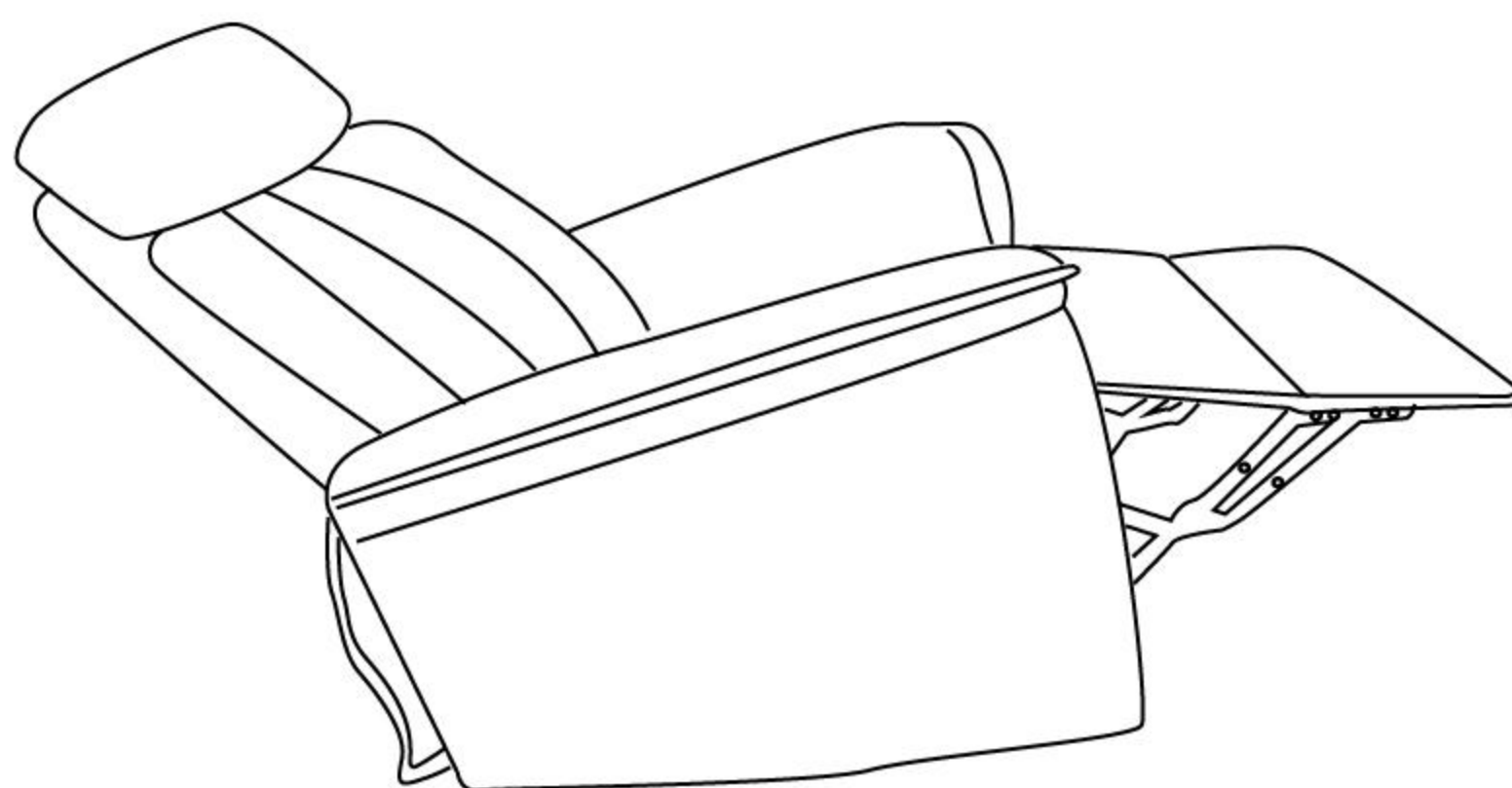
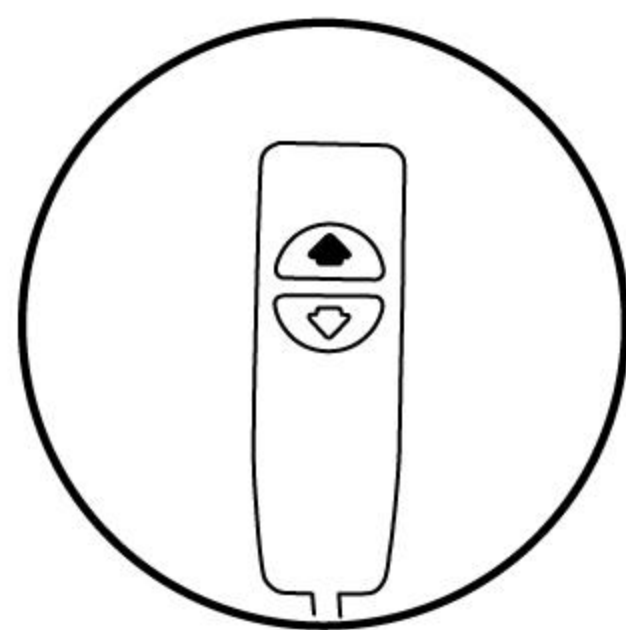



# Sofa assembly instruction

Comment utiliser la télécommande pour l'aide d'urgence?

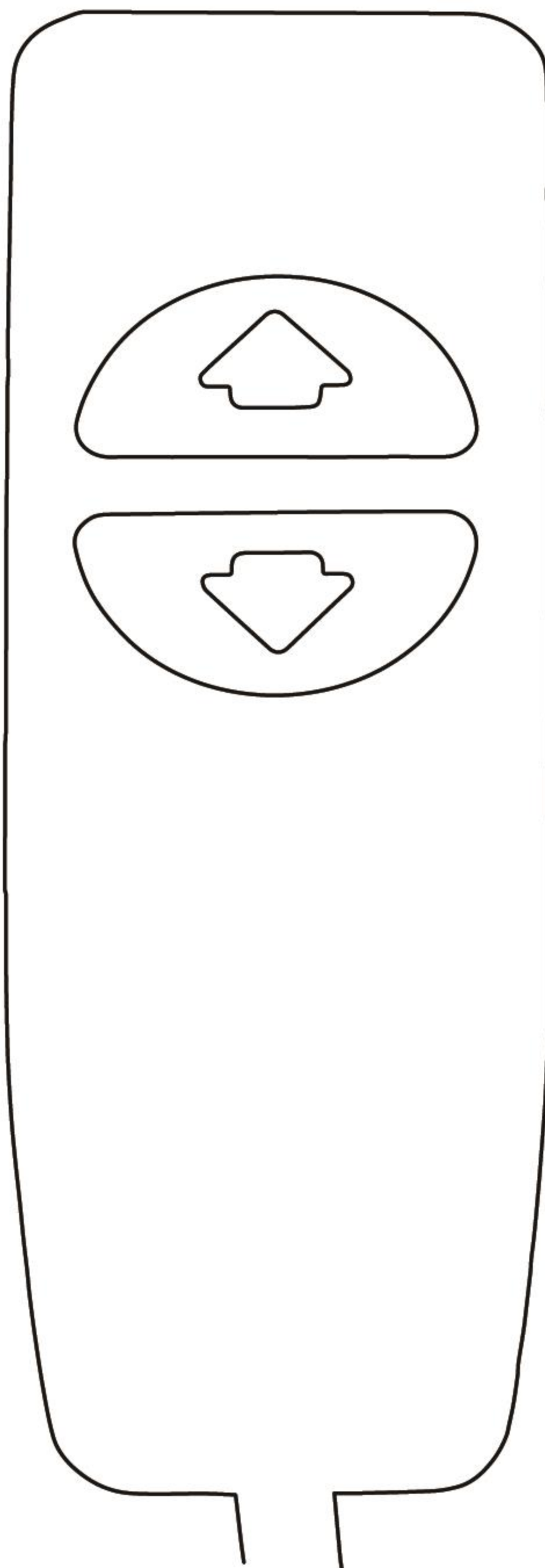

le dossier est droit, le pied position allongée est abaissé (position assise) ;  
maintenir la pression : incliner le canapé vers l'avant (aide à la verticalisation).



Déplacez le dossier vers le bas, la partie pieds vers le haut (position allongée).

# Sofa assembly instruction

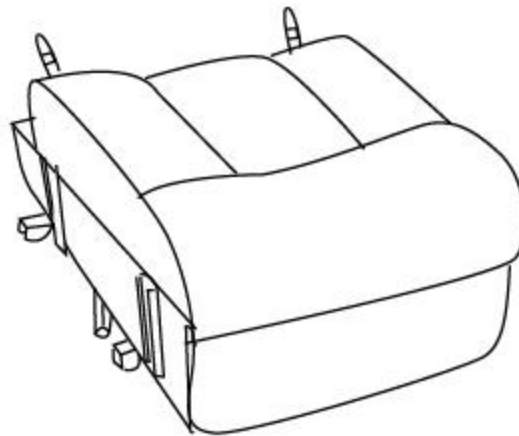
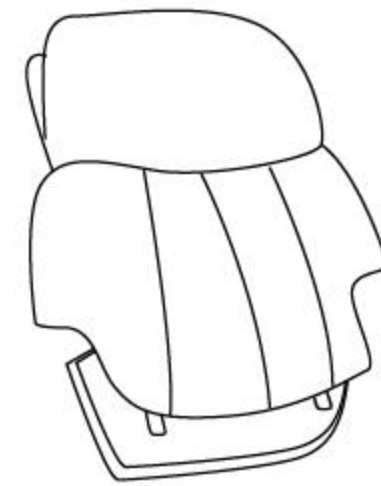
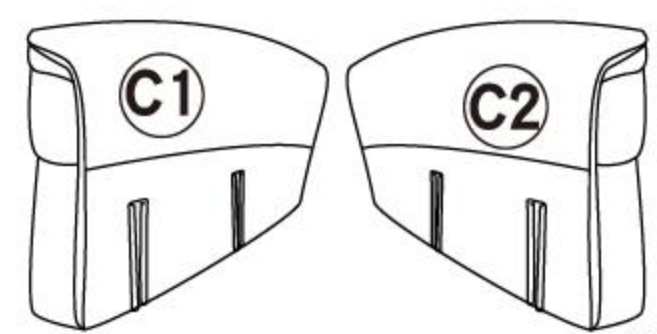
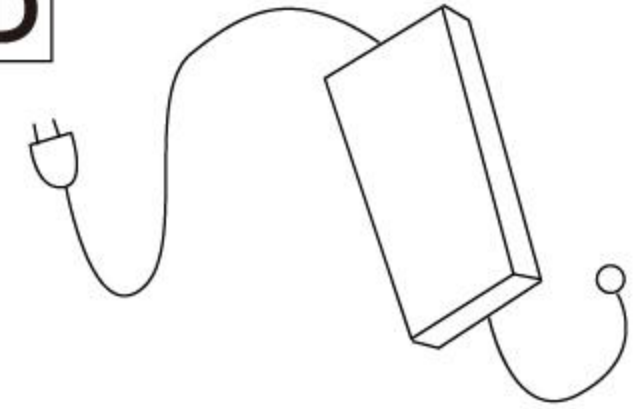
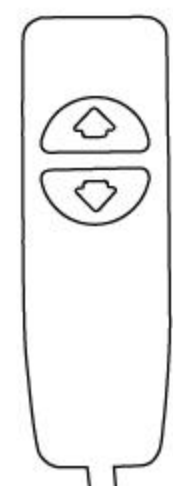
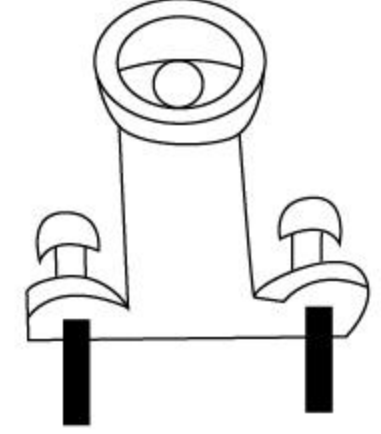
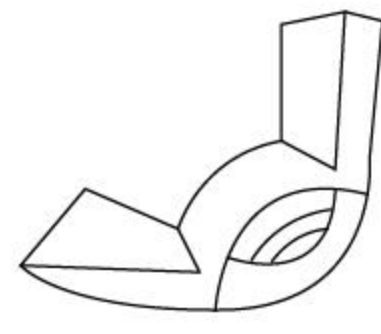
<b>A</b>  Base de la silla 1x	<b>B</b>  Respaldo 1x	<b>C</b>  Reposabrazos izquierdo y derecho 2x	<b>D</b>  Cable de alimentación 1x
<b>E</b>  Mando a distancia 1x	<b>F</b>  Parte1 2x	<b>G</b>  Parte2 4x	

## PASO 1

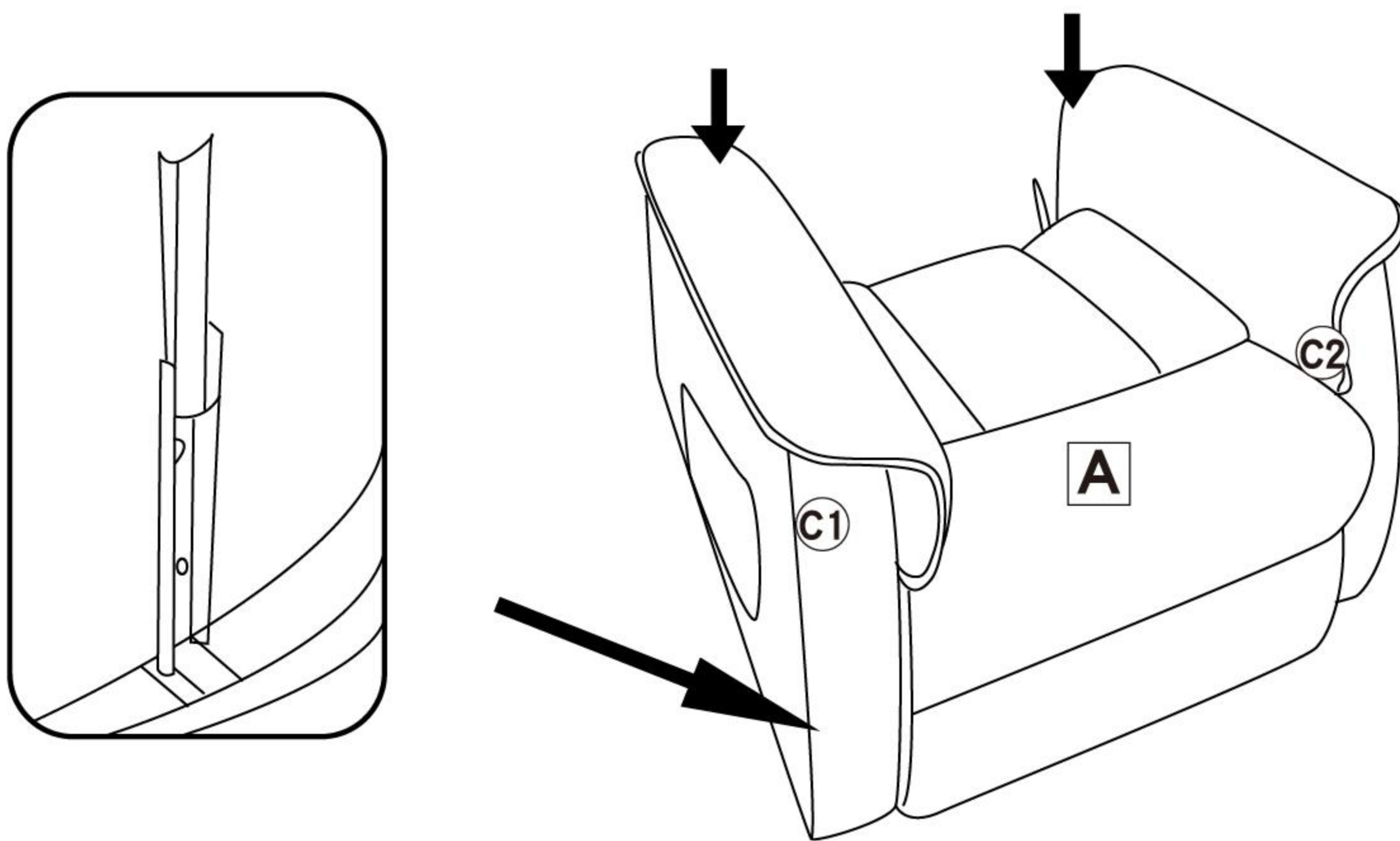

## PASO 2

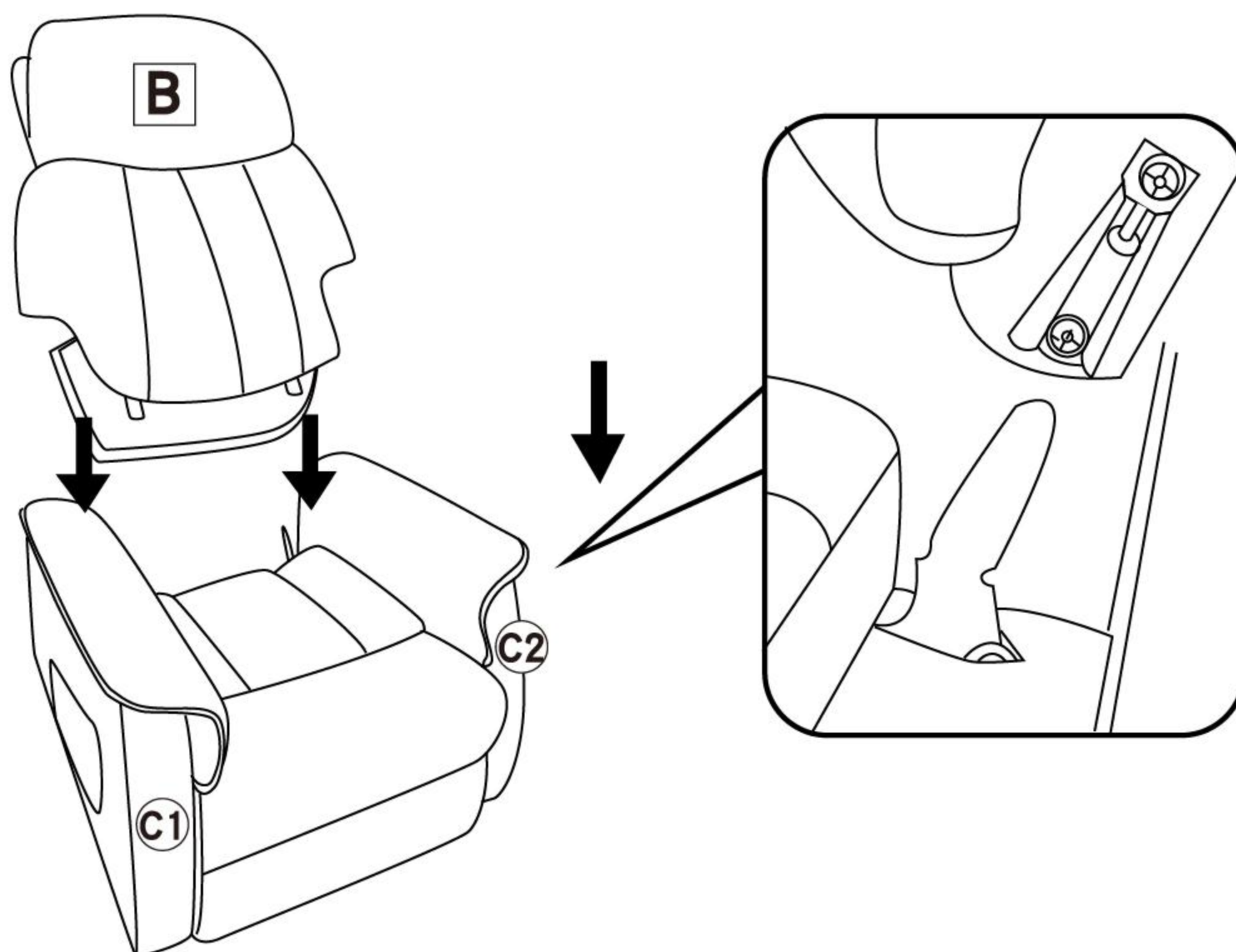



# Sofa assembly instruction

## PASO 3

La toma USB en la parte inferior del reposabrazos del sofá.

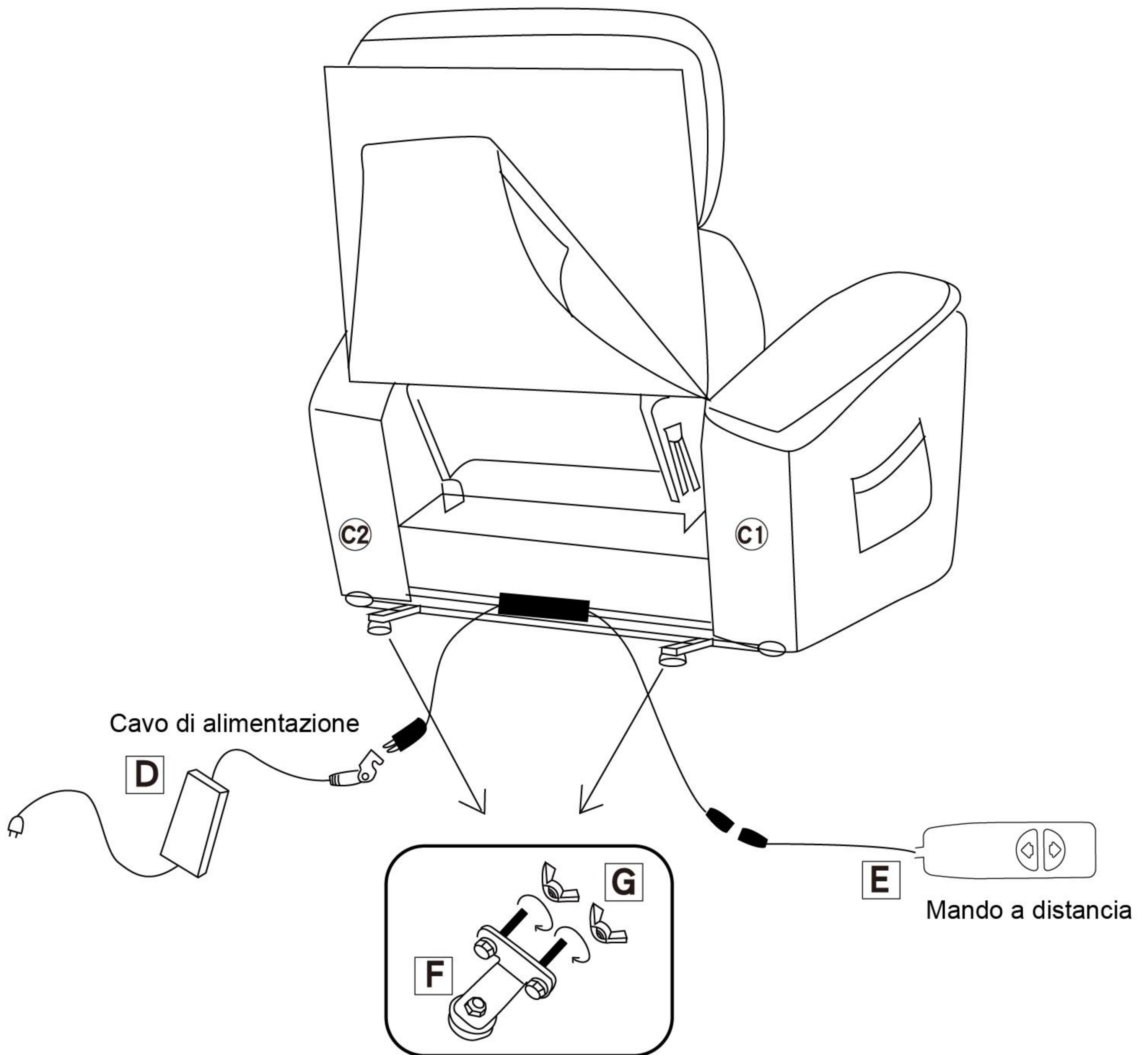

# Sofa assembly instruction

¿Cómo revestir?

Presione

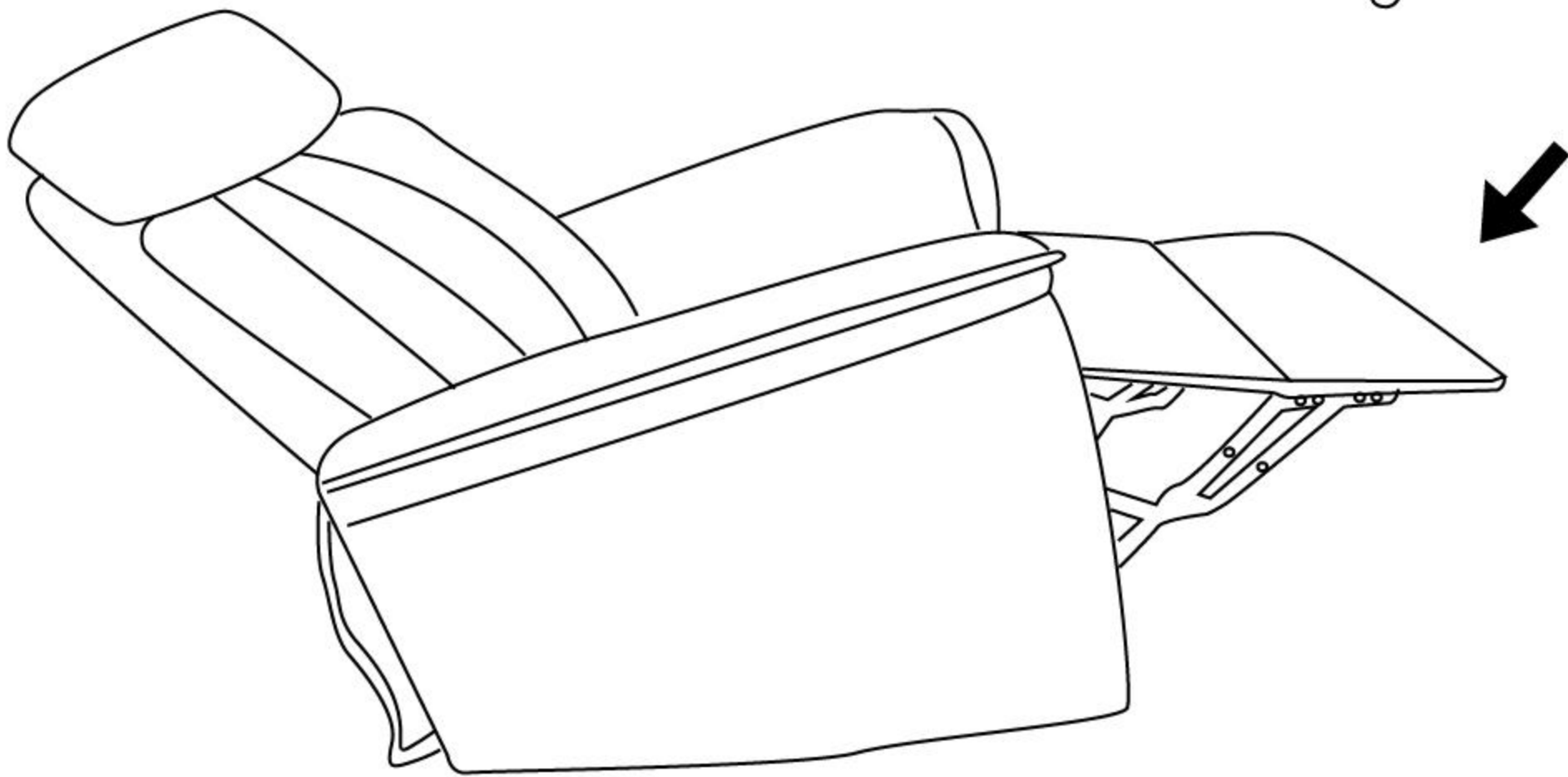
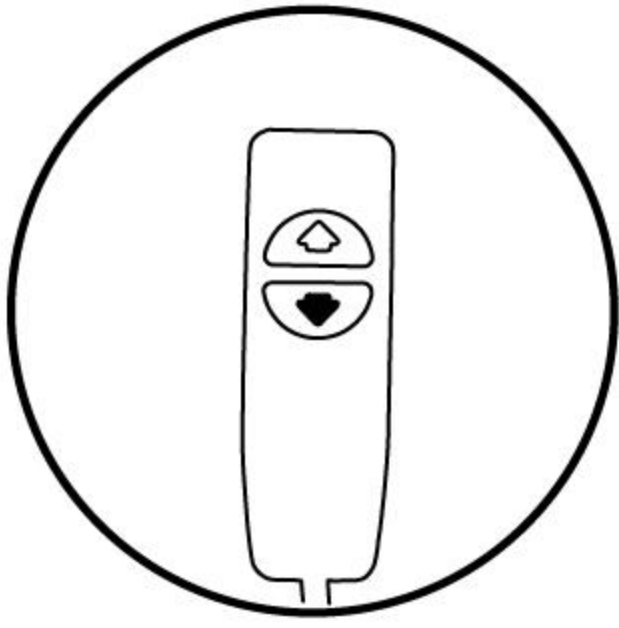

¿Cómo se puede conseguir que el reposapiés se enganche en un soporte?

Presione

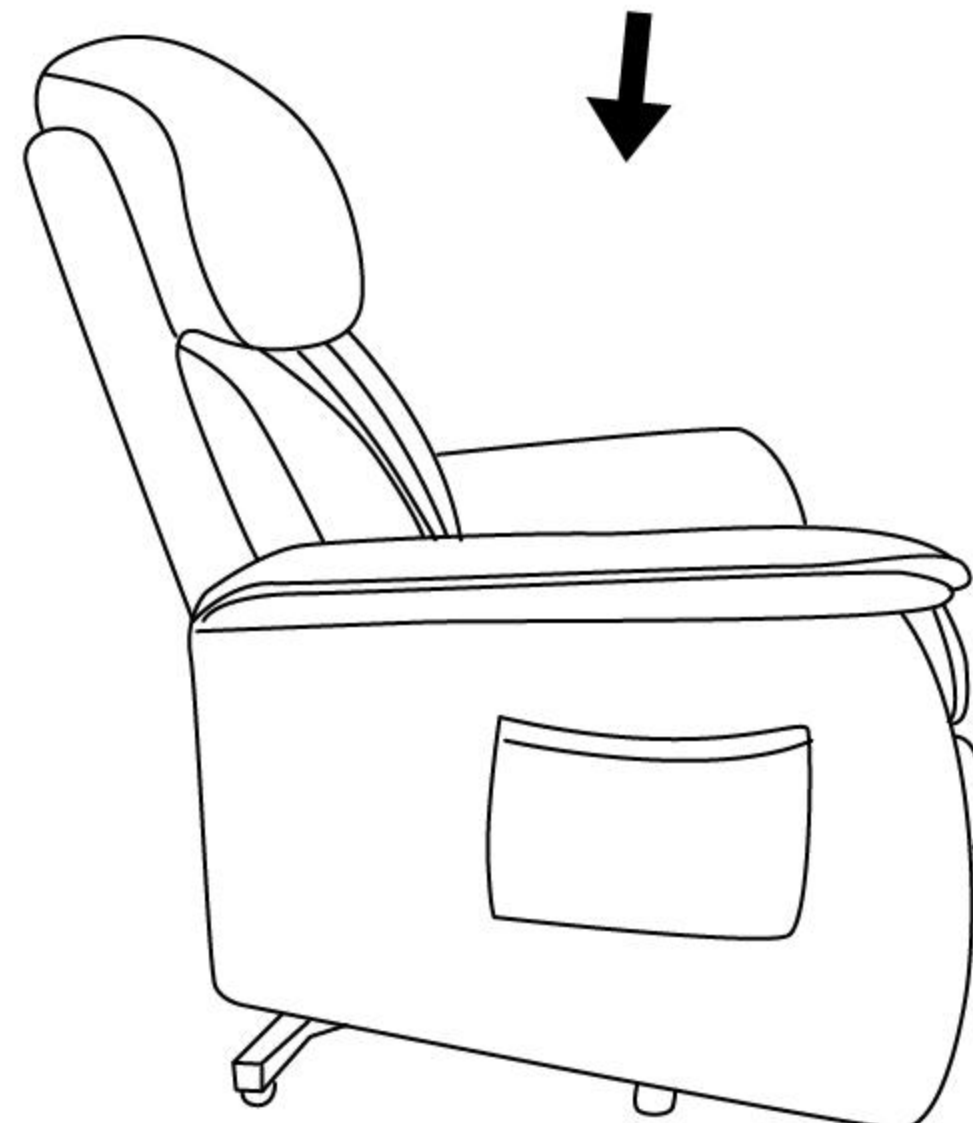
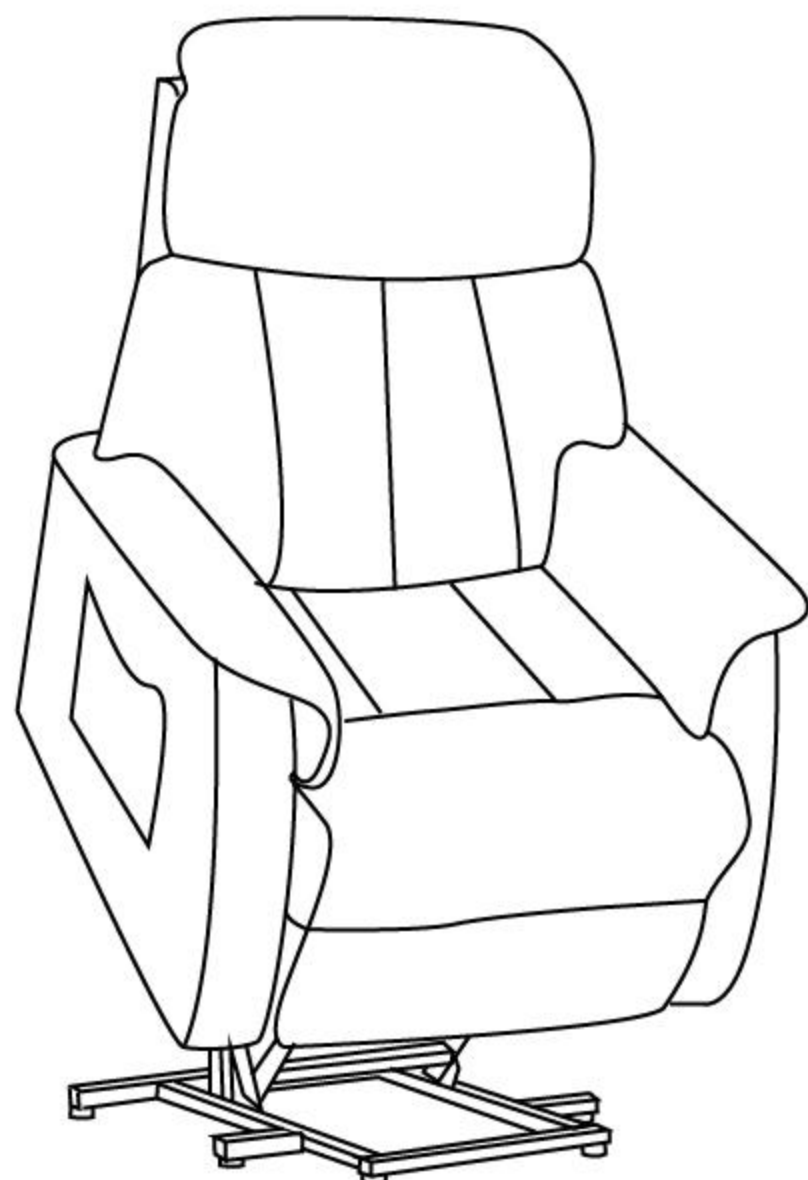
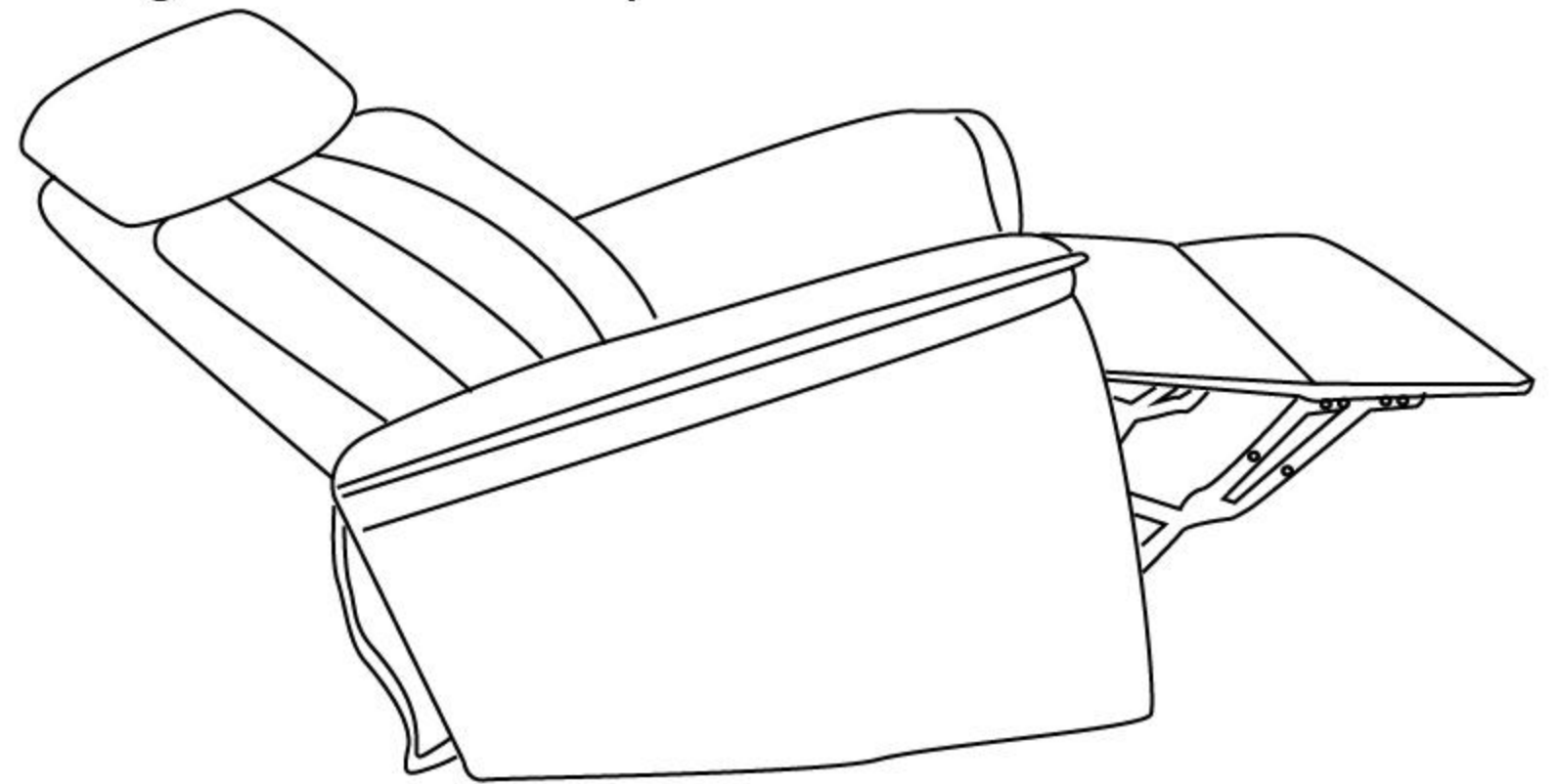
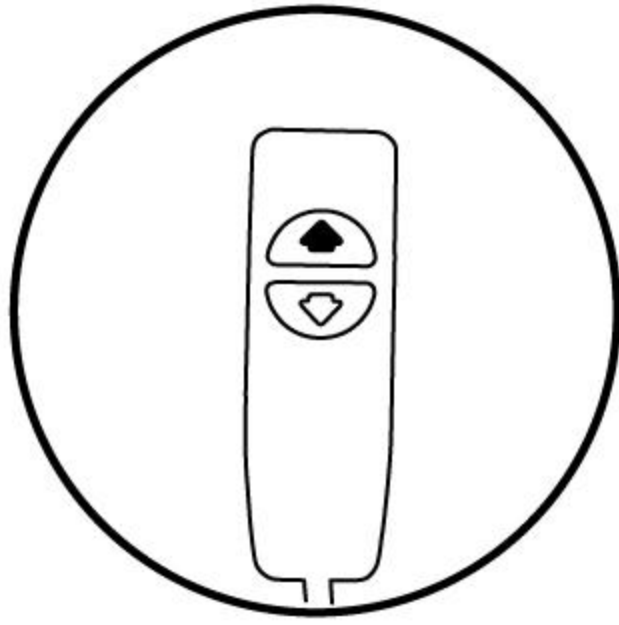



# Sofa assembly instruction

¿Cómo se utiliza el mando a distancia del bipedestador?

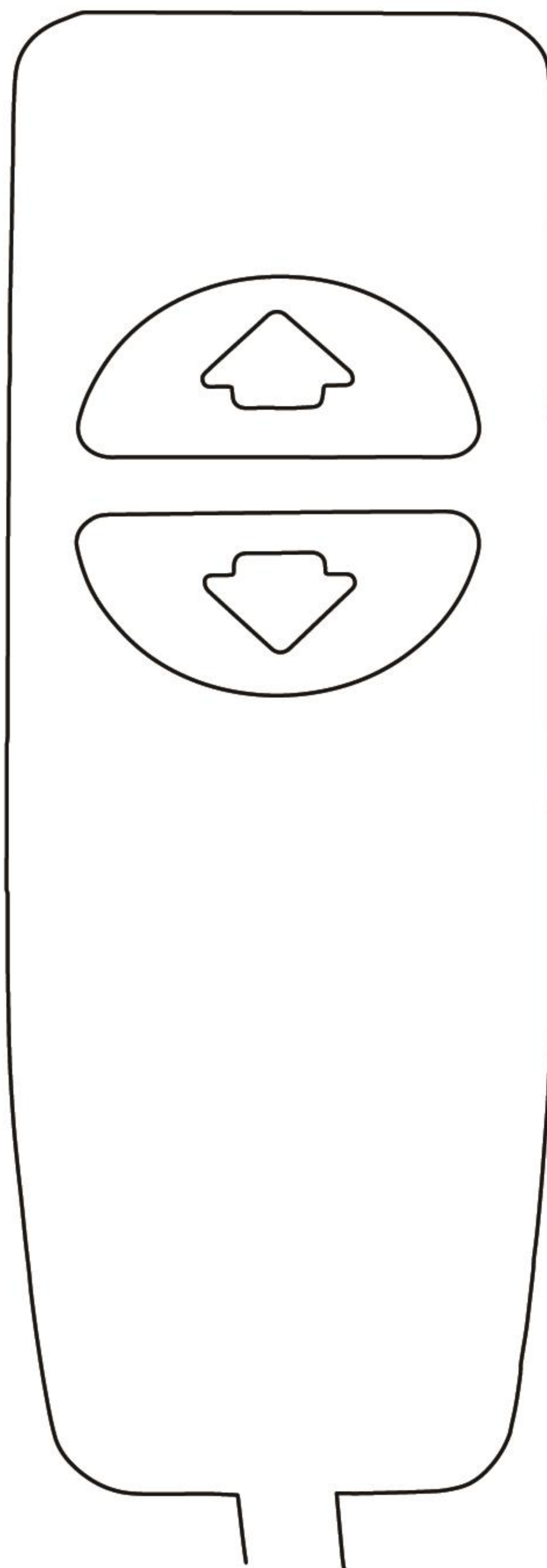

respaldo recto, sección de los pies hacia abajo (posición sentada);  
seguir presionando: inclinar el sofá hacia delante (ayuda de pie).



Mover el respaldo hacia abajo, la sección de los pies hacia arriba (posición acostada).

# Sofa assembly instruction

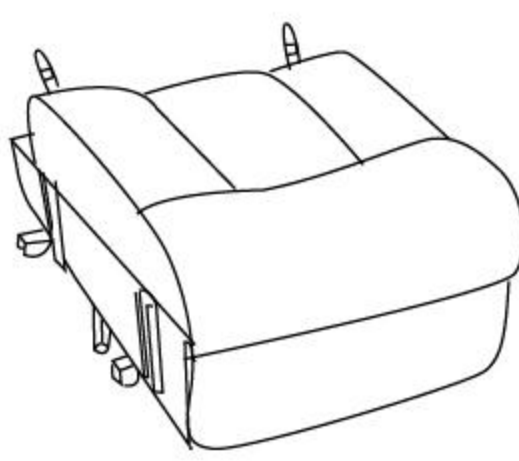
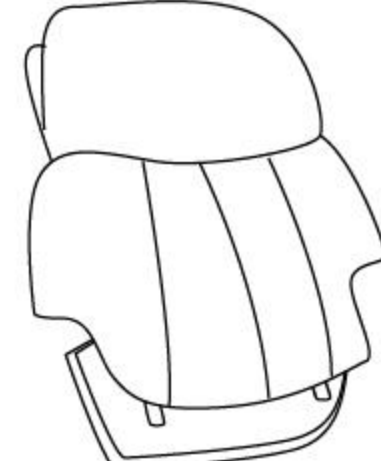
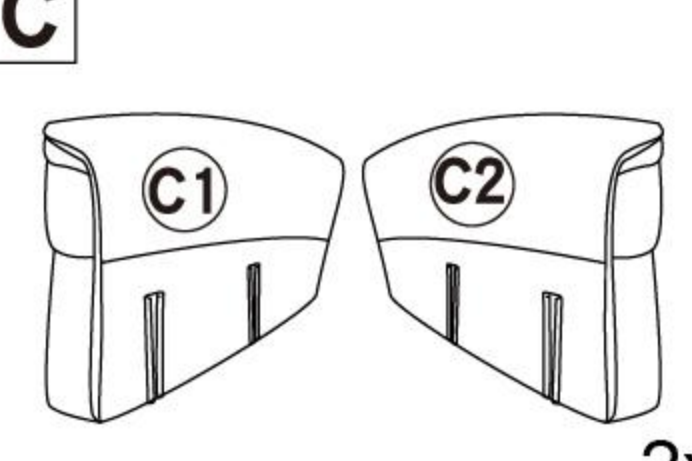
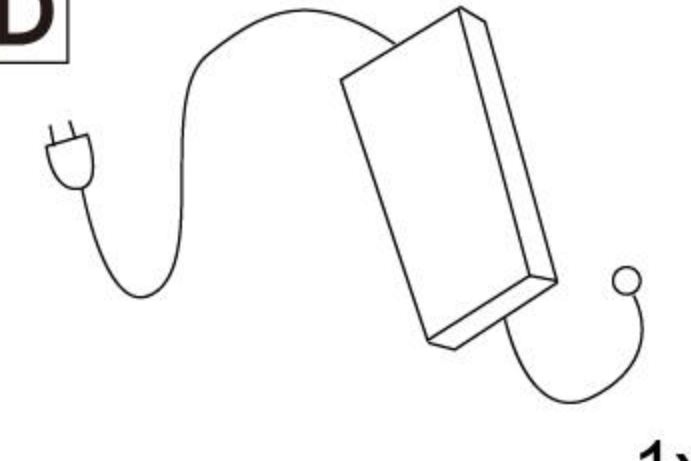
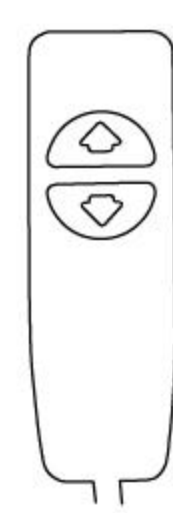
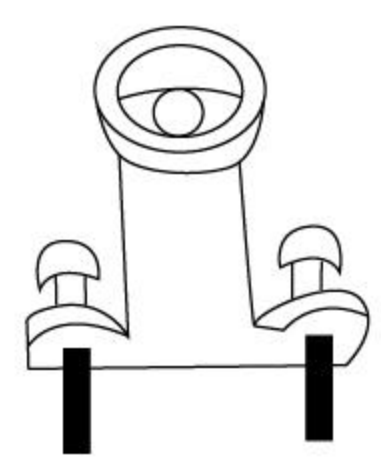
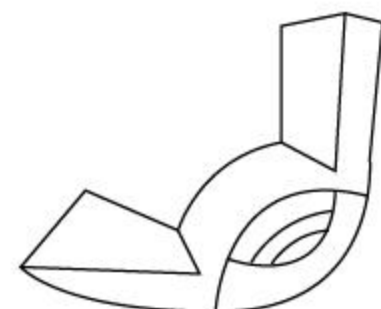
<b>A</b>  Base della sedia 1x	<b>B</b>  Schienaler 1x	<b>C</b>  bracciolo sinistro e destro 2x	<b>D</b>  Cavo di alimentazione 1x
<b>E</b>  Telecomando 1x	<b>F</b>  Parte1 2x	<b>G</b>  Parte2 4x	

## PASSO 1

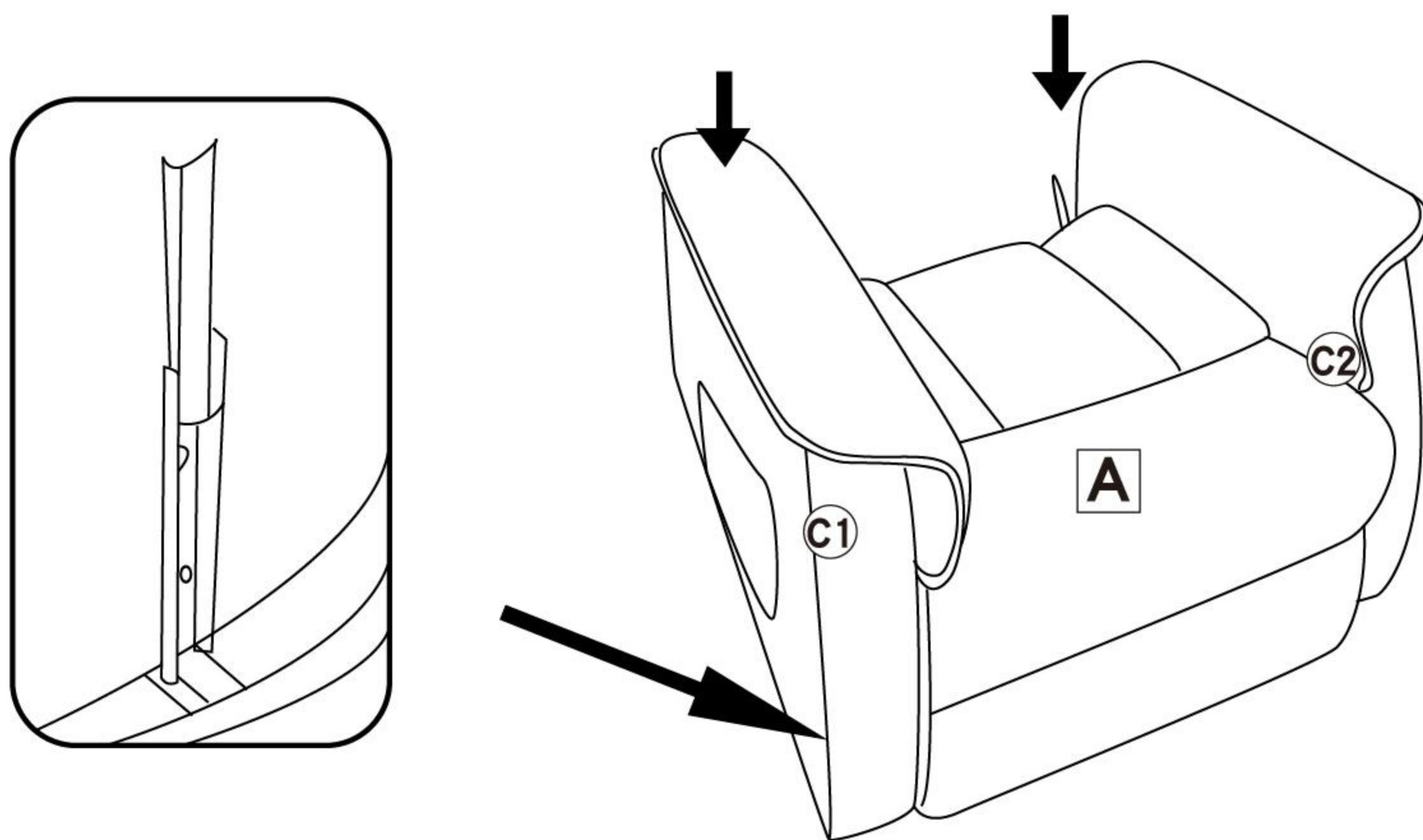

## PASSO 2

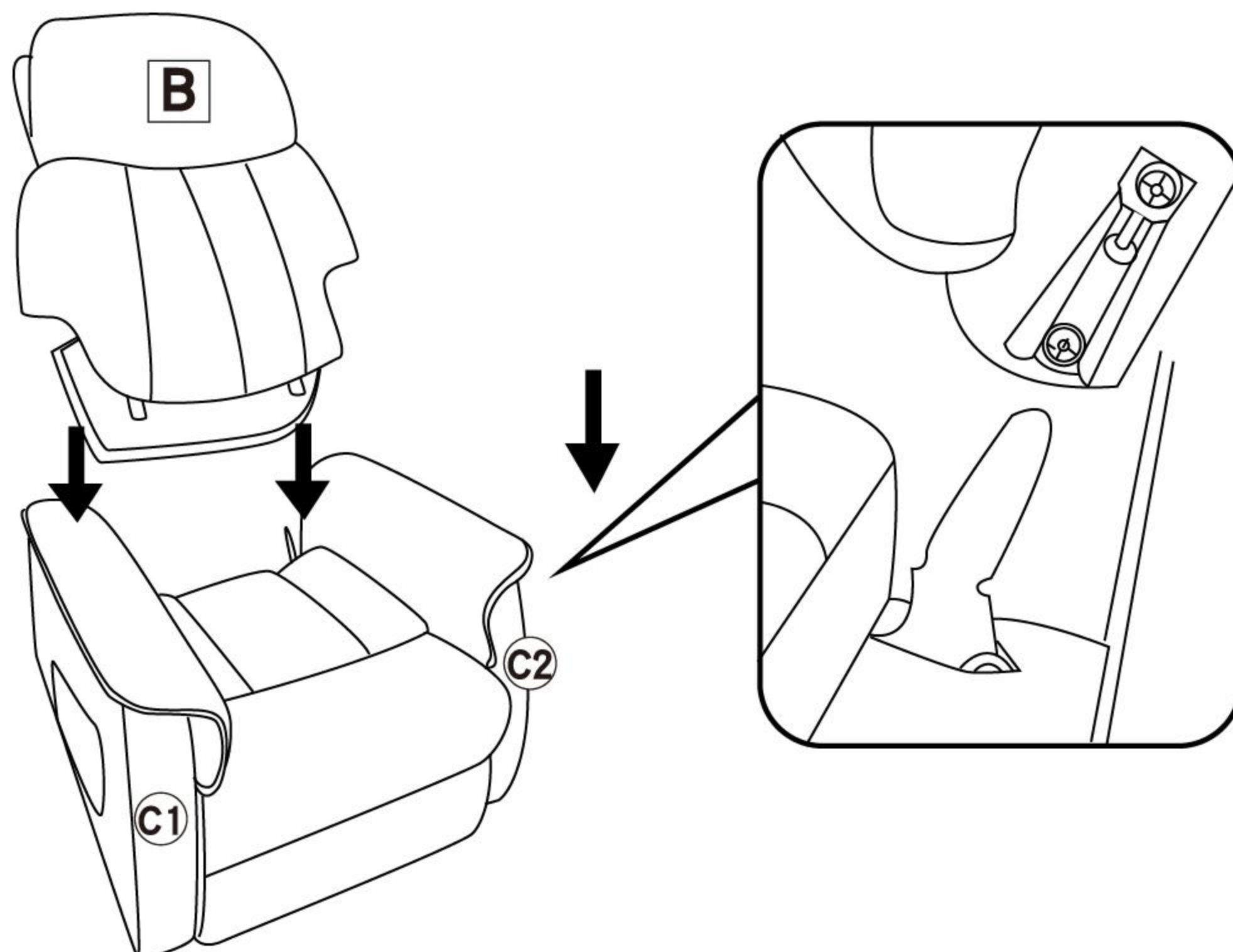



# Sofa assembly instruction

## PASSO 3

La presa USB nella parte inferiore del bracciolo del divano.

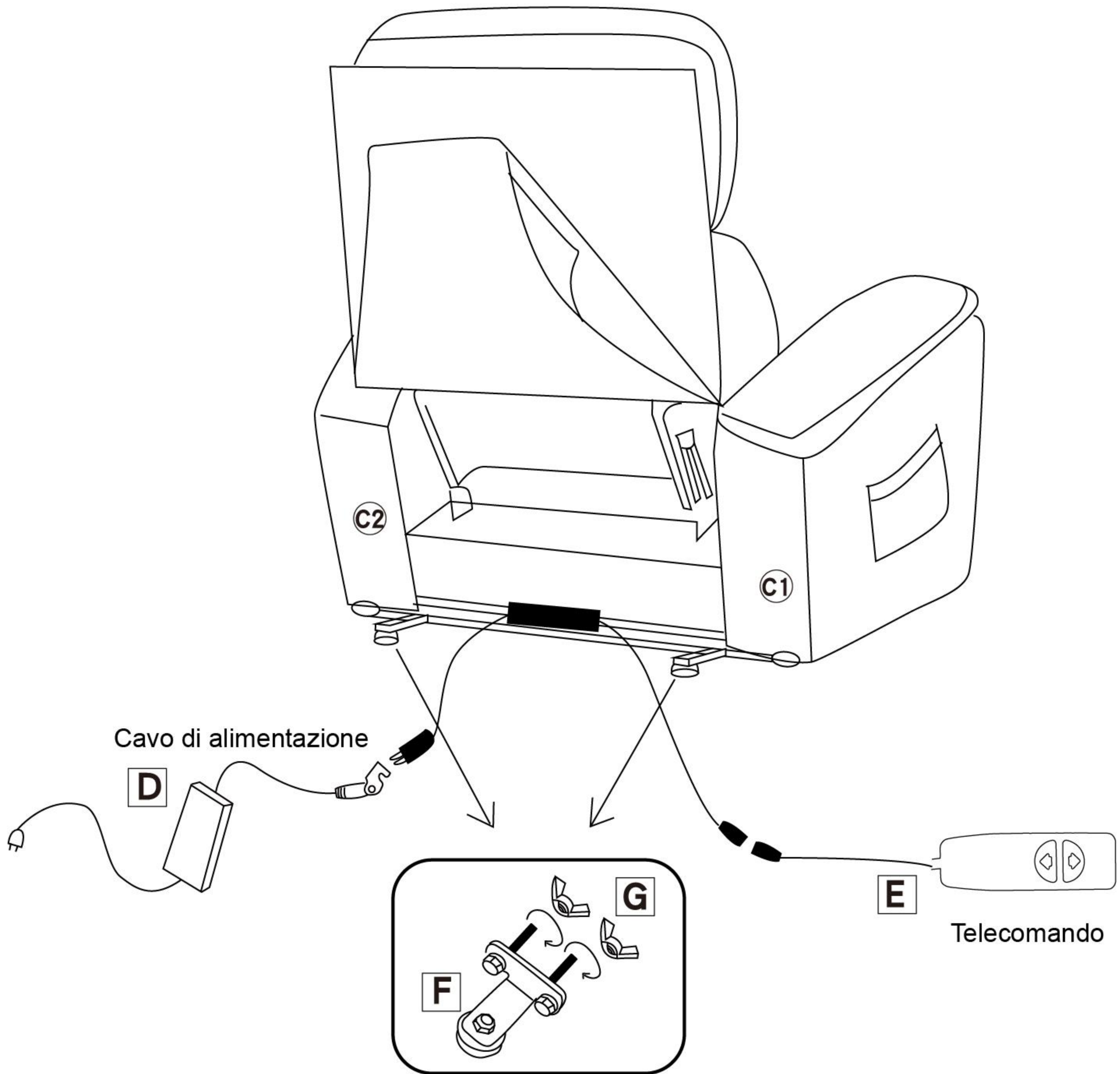

# Sofa assembly instruction

Come riallinearsi?

Premere

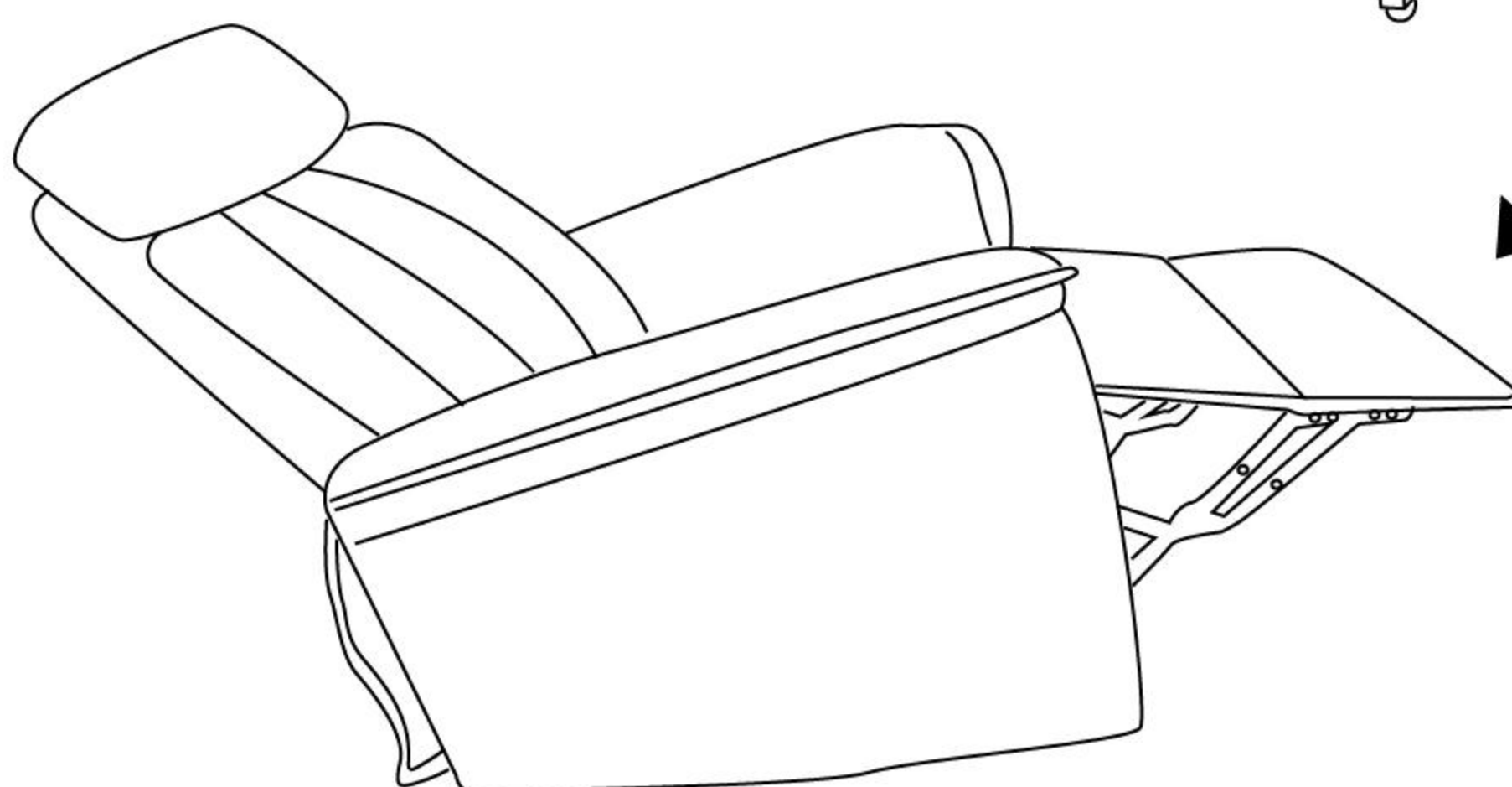
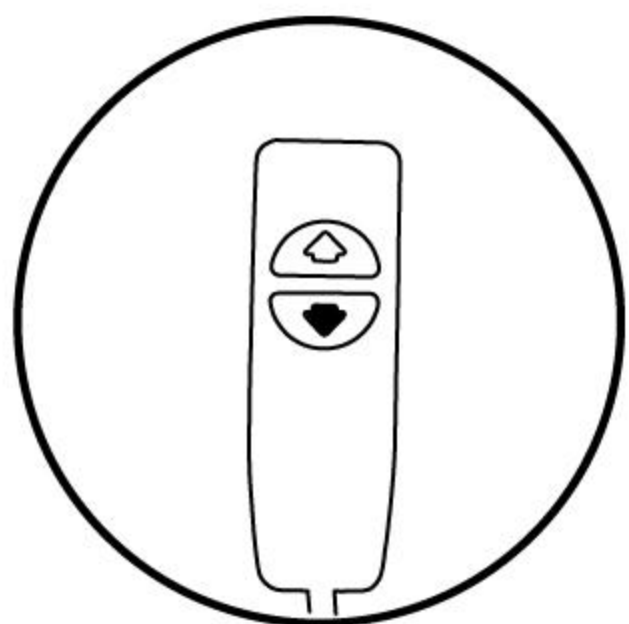

Come si fa ad agganciare il poggiatesta ad un supporto?

Premere

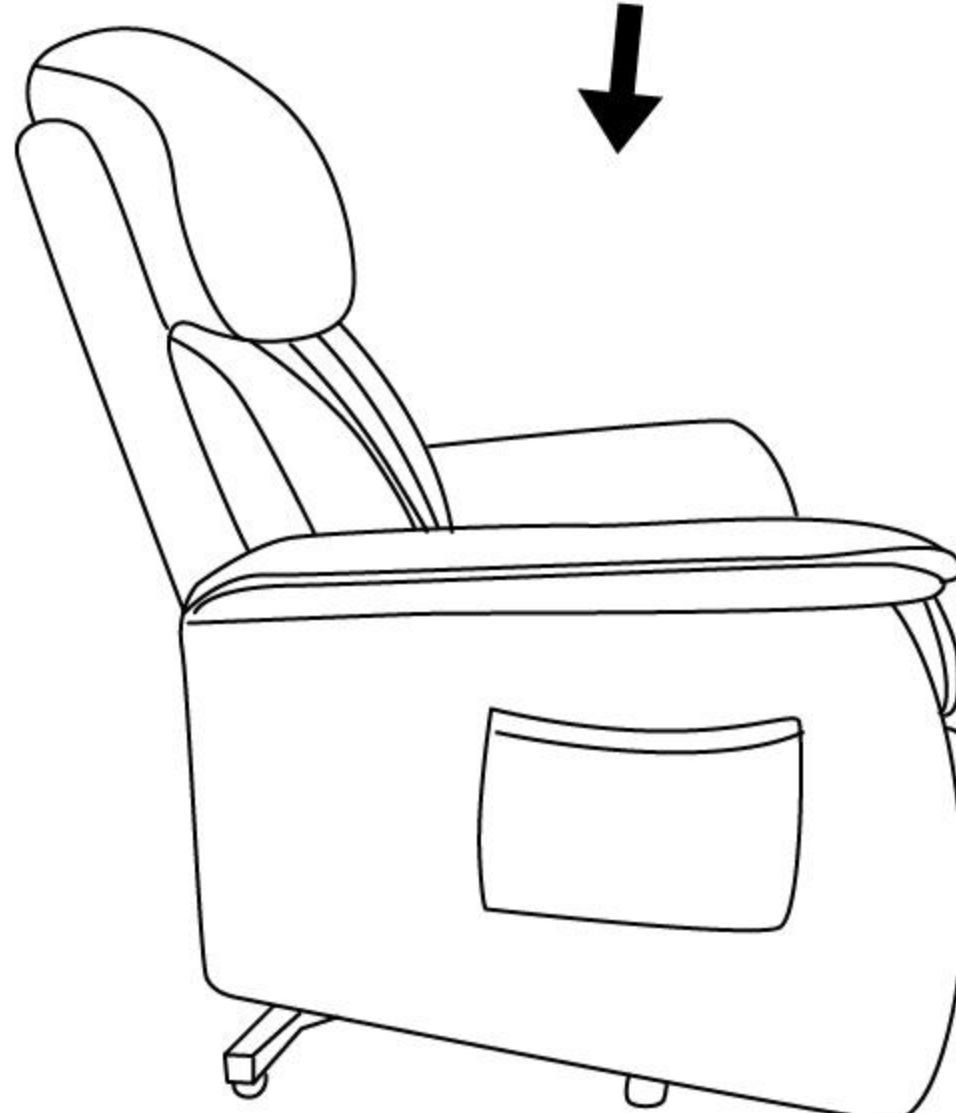
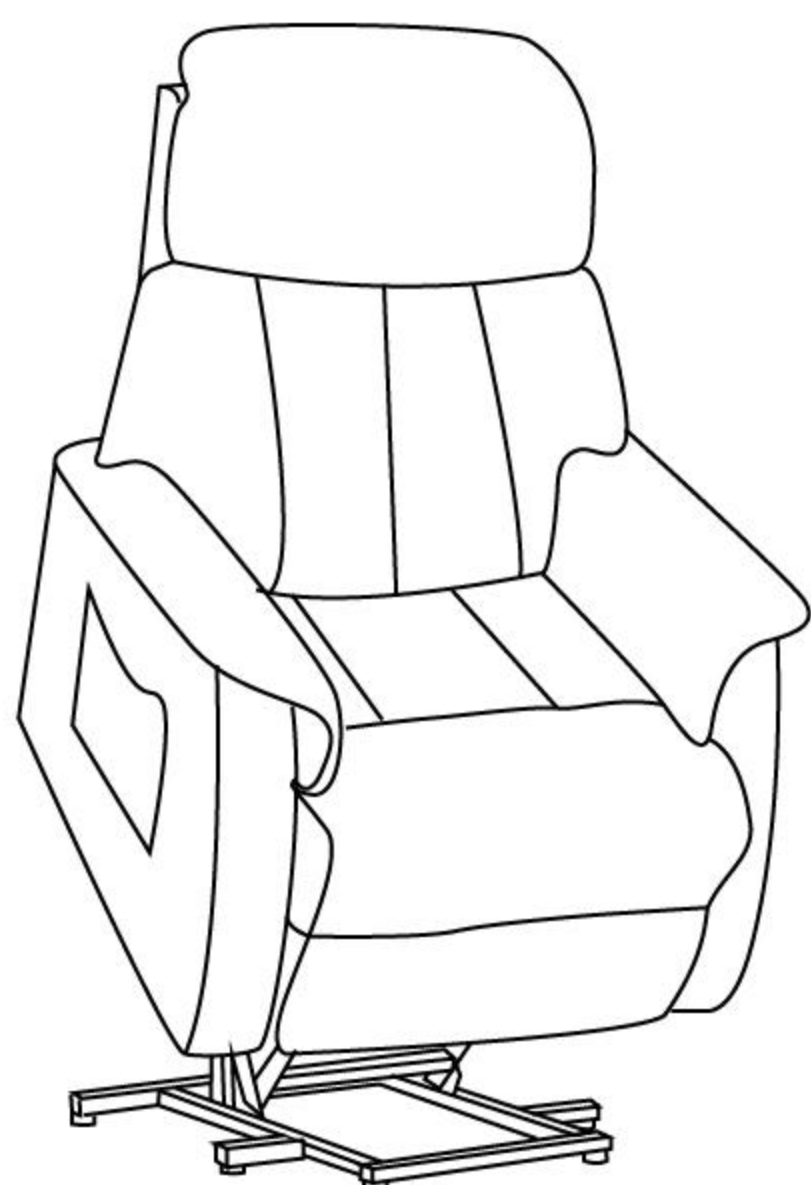
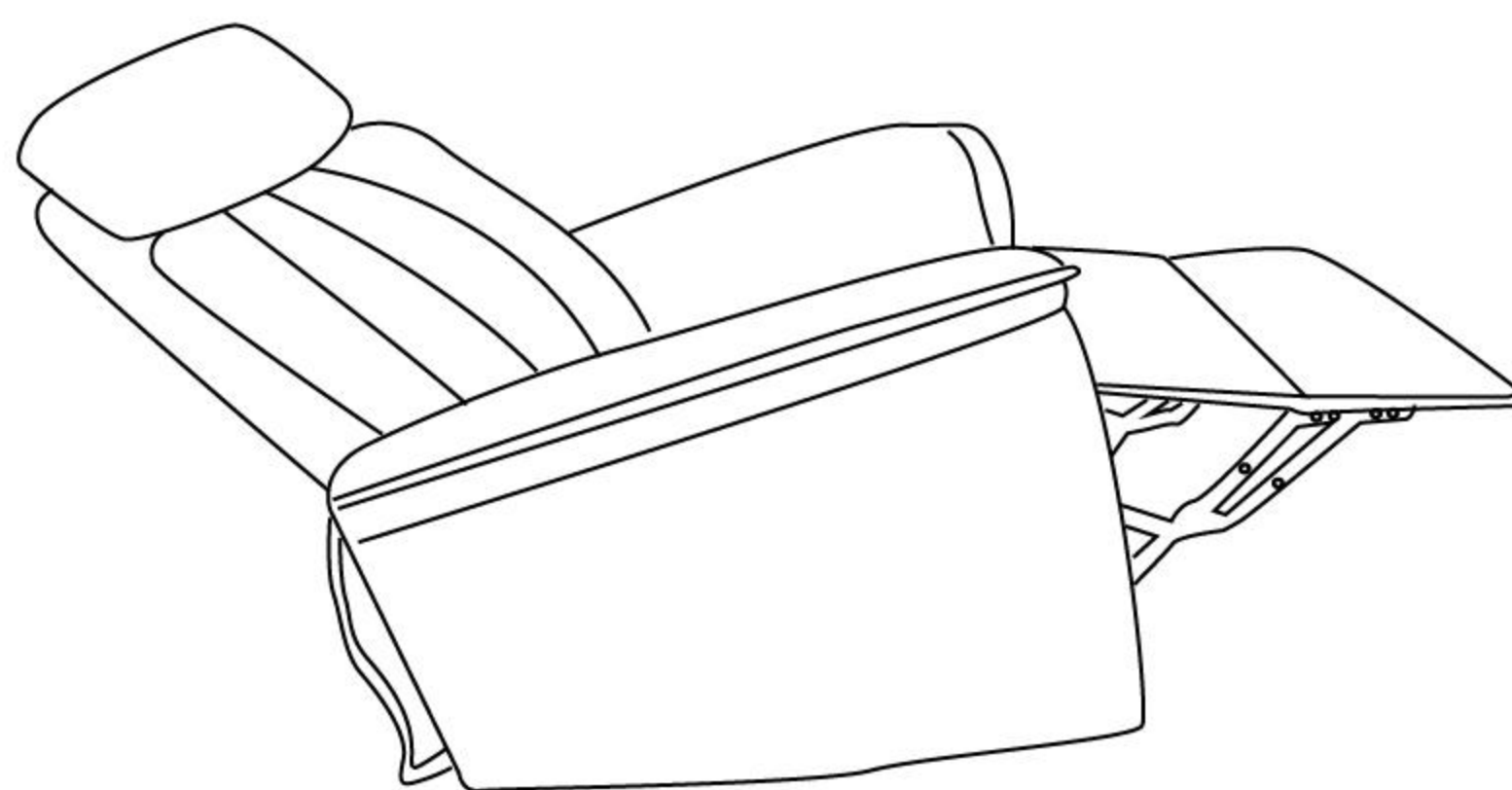
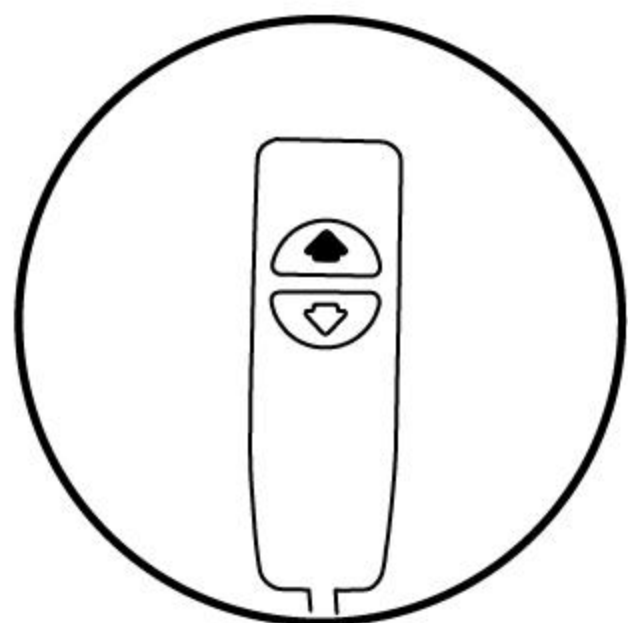



# Sofa assembly instruction

Come si usa il telecomando per l'ausilio stand-up?

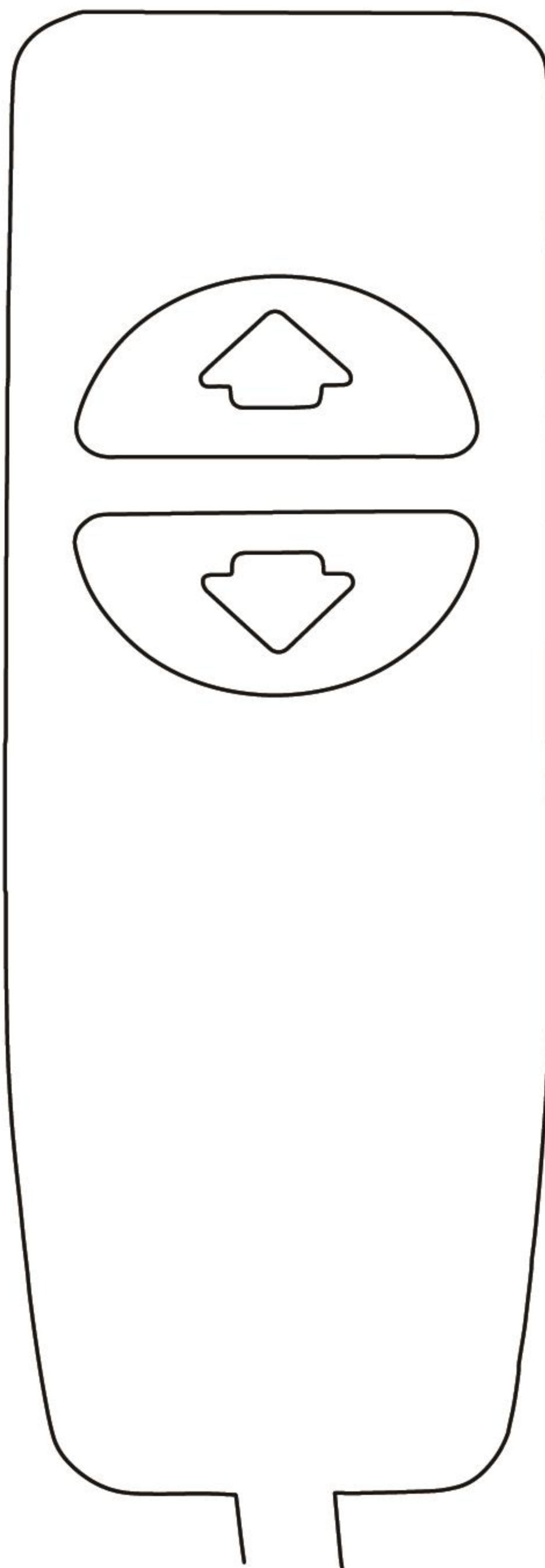

schienale dritto, parte dei piedi in basso (posizione seduta);  
continuare a premere: inclinare il divano in avanti (ausilio per alzarsi in piedi).



Spostare lo schienale verso il basso, la sezione dei piedi verso l'alto (posizione sdraiata).



**MCombo**

**Pfillo GmbH**

---

Adresse: Kreuzweg 60, 47809 Krefeld

E-mail: [pfillo.de@gmail.com](mailto:pfillo.de@gmail.com)